

MGP 15 Medical Grade Projector



Owners Manual

R9003110

BarcoView

Th. Sevenslaan 106, B-8500 Kortrijk

Phone: +32 56.23.32.44

Fax: +32 56.23.33.74

E-mail: sales.medical.barcoview@barco.com

Visit us at the web: www.barcomedical.com

Federal Communications Commission (FCC Statement)

This equipment has been tested and found to comply with the limits for a class A digital device, pursuant to Part 15 of the FCC rules. These limits are designed to provide reasonable protection against harmful interference when the equipment is operated in a commercial environment. This equipment generates, uses, and can radiate radio frequency energy and, if not installed and used in accordance with the instruction manual, may cause harmful interference to radio communications. Operation of this equipment in a residential area may cause harmful interference, in which case the user will be responsible for correcting any interference.

Trademarks

Brand and product names mentioned in this manual may be trademarks, registered trademarks or copyrights of their respective holders. All brand and product names mentioned in this manual serve as comments or examples and are not to be understood as advertising for the products or their manufactures.

TABLE OF CONTENTS

1. About this manual	5
1.1 Objective	5
2. Packaging and Dimensions	7
2.1 Box content	7
2.2 Projector Packaging	7
2.3 Lens Packaging	8
2.4 Dimensions	8
3. Installation Guidelines	11
3.1 Safety warnings	11
3.2 Installation guidelines	11
3.3 Projector configurations	12
3.4 Lenses	16
3.4.1 Lenses	16
3.4.2 Lens formulas	16
3.4.3 Lens installation	17
3.4.4 Removing the lens	17
3.4.5 Cleaning the lens	18
3.5 Batteries	18
3.5.1 Battery installation	18
4. Connections	19
4.1 Power connection	19
4.2 Input Source connections	20
4.2.1 Input section	20
4.2.2 Input facilities	20
4.2.3 5-Cable input	20
4.2.4 Composite Video Input	21
4.2.5 S-Video input	22
4.2.6 Digital Visual Interface (DVI) input	23
4.2.7 Computer input	24
4.3 Communications Connections	24
4.3.1 RS232 IN connection	24
4.4 Connecting the MGP in Dicom Theatre®	25
5. Getting started	27
5.1 Quick startup	27
5.2 RCU & Local keypad	29
5.3 Terminology overview	31
5.4 Switching on	32
5.5 Lamp runtime	32
5.6 Quick set up adjustments	33
5.6.1 Quick lens Adjustment	34
5.6.2 Using the RCU	34
5.7 Projector address	35
5.7.1 Address setting	35
5.7.2 Displaying and Programming addresses into the RCU	36
5.8 Digital Zoom	36
5.9 Menu structure	37
5.10 Using the menu	37
5.11 Using the Dialogboxes	38
6. Introduction to Medical Visualization systems	41
6.1 DICOM conformance	41
6.2 Architecture of a typical medical visualization system	41
6.3 Overview of Barco's DICOM THEATRE®	42
6.4 Introduction to MGP configuration	42
6.4.1 MGP main grayscale configuration tools	42
7. Main Menu	45
7.1 Autosetup	45
8. Adjustments	47
8.1 Contrast	47
8.2 Brightness	48
8.3 Phase	49
8.4 Gamma	49
8.5 Custom color temperature adjustment	49
8.6 Scaling	50
8.7 Aspect ratio	51
8.8 Positioning	52
8.9 Image settings	53

8.10	RGB Low Pass filter	56
8.11	Standby Timer	57
8.12	Blanking	58
8.13	Autosetup parameters	60
9.	Input Selection	63
9.1	Input selection	63
9.2	Displaying the Logo	64
9.3	Pause	65
9.4	Freeze	66
10.	Settings	67
10.1	Color temperature	67
10.1.1	Color temperatures in greyscale mode reproduction	67
10.1.2	Color temperature in a standalone projector setup	67
10.1.3	Color temperature in a closed loop medical visualization system	68
10.2	Display function	69
10.2.1	Display function in a standalone projector setup	69
10.2.2	Display function in a closed loop medical visualization system	70
10.3	Restoring the factory settings	71
10.4	Black and white selection	71
10.5	User Control	73
10.6	Lamp mode selection	74
10.7	Runtime warning	75
10.8	Input Balance	76
10.9	AGC on Video	80
10.10	Manual Gain Control	80
10.11	Lamps	81
10.11.1	History	81
10.11.2	Reset runtime	82
11.	Tools	85
11.1	Source switching mode	85
11.2	Picture in Picture	86
11.2.1	Introduction to PiP	86
11.2.2	Preferences	87
11.3	PiP select	88
11.4	Add window	89
11.5	Remove window	90
11.6	PiP Lay-out	91
11.6.1	PiP Save	91
11.6.2	PiP rename layout	92
11.6.3	PiP delete layout	92
11.7	PiP Adjust	93
11.8	Background	94
11.9	Logo	95
12.	Video formats	97
12.1	Introduction	97
12.2	Load	97
12.3	Edit	98
12.4	Rename	100
12.5	Copy	101
12.6	Delete	102
13.	Information	105
13.1	Product identification	105
13.2	Configuration	105
13.3	Runtimes	106
13.4	Current Input format	106
13.5	Diagnostics	107
13.6	Quick access keys	108
14.	Installation	111
14.1	Lens adjustments	111
14.2	Projector address	112
14.3	Orientation	113
14.4	Portrait / Landscape	114
14.5	Language	115
14.6	RS232 baudrate	116
14.7	Security	116
14.8	Change password	118
14.9	Auto Menu Exit	119
14.10	Automatic startup	120
14.11	Textbox	121
14.12	Menu bar position	122
14.13	Status bar position	122

14.14 Sliderbox position	123
15. Cleaning the dustfilters	125
15.1 Dustfilters	125
15.2 Cleaning	125
16. Standard Image Files	127
16.1 Table overview	127

1. ABOUT THIS MANUAL

1.1 Objective



This manual is dedicated to the Barco MGP LCD projector and describes the way the projector should be operated and the use of the software menus .

In the practice the MGP is to be implemented in a total medical visualization system . For this reason a chapter is inserted giving a brief introduction to medical systems and in particular the Barco's DICOM THEATRE® . The aim of the chapter being only the illustration of the role to be played by the projector in such a system, and that way trying to give a better image of the use of some parameters within the menustucture.

For more details about the system refer to the system manual.

2. PACKAGING AND DIMENSIONS

Overview

- Box content
- Projector Packaging
- Lens Packaging
- Dimensions

2.1 Box content



CEE7

European power plug to connect the power cord to the wall outlet.



ANSI 73.11

American power plug to connect the power cord to the wall outlet.

Content

- 1 projector (weight \pm 12,6 kg or 27.8 lbs)
- 1 remote control unit RCU + 2 batteries.
- 2 power cables with outlet plug type CEE7 and ANSI 73.11.
- 1 owners manual
- 1 safety manual

2.2 Projector Packaging

Way of Packaging

The projector is packed in a carton box. To provide protection during transportation, the projector is surrounded with foam. The package is secured with banding and fastening clips.

To unpack

1. Release the fastening clips. (image 2-1)
2. Remove the banding. Handle as shown in the drawing.
3. Take the projector out of its shipping carton and place it on a table. (image 2-2)

2. Packaging and Dimensions

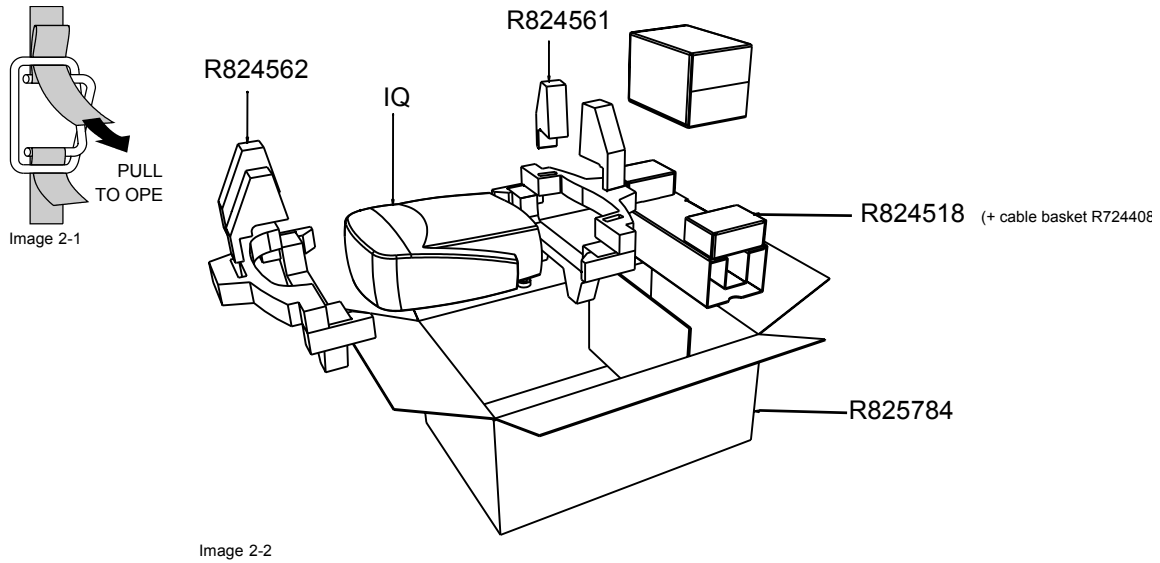

Save the original shipping carton and packing material, they will be necessary if you ever have to ship your projector. For maximum protection, repack your projector as it was originally packed at the factory.



Save the original shipping carton and packing material, they will be necessary if you ever have to ship your projector. For maximum protection, repack your projector as it was originally packed at the factory.



CAUTION: Never transport the projector with the lens mounted on it !
Always remove the lens before transporting the projector.

2.3 Lens Packaging

Way of Packaging

Lenses are supplied as an individual item.

They are packed in a carton box.



Save the original shipping carton and packing material, they will be necessary if you ever have to transport the lens.



CAUTION: Never transport the projector with the lens mounted on it !
Always remove the lens before transporting the projector.

2.4 Dimensions

Dimensions overview

Dimensions are given in mm (1 inch = 25.4 mm)

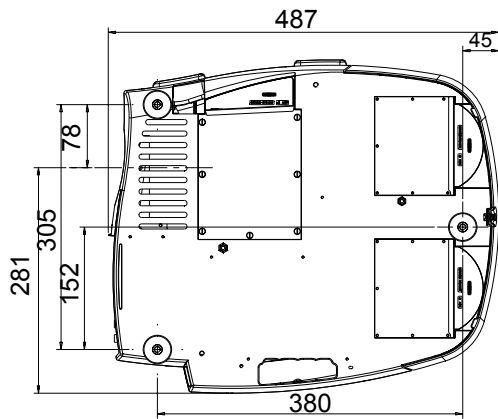

Length with different lenses, see table

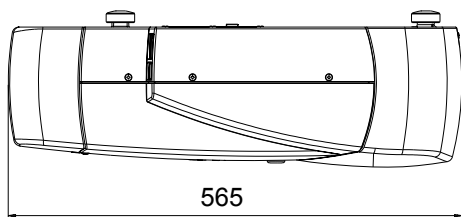
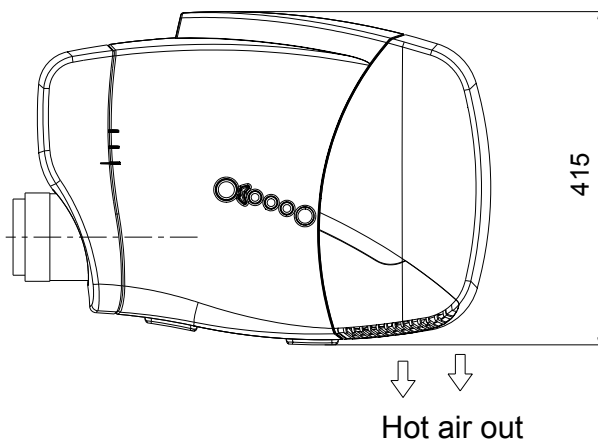
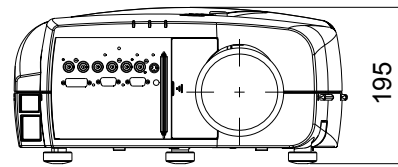
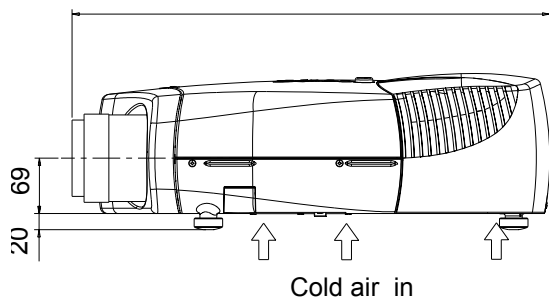

Image 2-3

2. Packaging and Dimensions

Lens	length of projector	combinable with cable basket	Remarks
SVD(2-2.5:1)	545mm	YES	Length with cable basket = 565mm
QVD(1.3-1.8:1)	600mm	YES	
QVD(1.9-2.6:1)	590mm	YES	
QVD(3.0-6.0:1)	620mm	YES	
QVD(0.85:1)	545mm	NO	
QVD(7.0:1)	540mm	YES	Length with cable basket = 560mm

3. INSTALLATION GUIDELINES

Overview

- Safety warnings
- Installation guidelines
- Projector configurations
- Lenses
- Batteries

3.1 Safety warnings



WARNING: Before installing the projector, read first the safety instructions in the safety manual (R5975258) delivered with the projector.

Insure that the projector is installed in an easy to evacuate room in case of a lamp explosion.

Mercury Vapor Warnings

Keep the following warnings in mind when using the projector. The lamp used in the projector contains mercury. In case of a lamp rupture, explosion there will be a mercury vapor emission. In order to minimize the potential risk of inhaling mercury vapors:

- Ensure the projector is installed only in ventilated rooms.
- Replace the lamp module before the end of its operational life.
- Promptly ventilate the room after a lamp rupture, explosion has occurred, evacuate the room (particularly in case of a pregnant woman).
- Seek medical attention if unusual health conditions occur after a lamp rupture, explosion, such as headache, fatigue, shortness of breath, chest-tightening coughing or nausea.

3.2 Installation guidelines

Ambient temperature check

Careful consideration of things such as image size, ambient light level, projector placement and type of screen to use are critical to the optimum use of the projection system.

Max. ambient temperature : 40 °C or 104 °F

Min. ambient temperature : 0 °C or 32 °F

The projector will not operate if ambient air temperature falls outside this range (0°C- 40°C or 32°F-104°F).

Environment

Do not install the projection system in a site near heat sources such as radiators or air ducts, or in a place subject to direct sunlight, excessive dust or humidity. Be aware that room heat rises to the ceiling; check that temperature near the installation site is not excessive



CAUTION: Harmful Environmental Contamination Precaution

Environment condition check

A projector must always be mounted in a manner which ensures the free flow of clean air into the projectors ventilation inlets as well as free flow at the ventilation outlets. The installation must also allow easy access to the consumable parts (dustfilters, lamps, ...) For installations in environments where the projector is subject to airborne contaminants such as that produced by smoke machines or similar (these deposit a thin layer of greasy residue upon the projectors internal optics and imaging electronic surfaces, degrading performance), then it is highly advisable and desirable to have this contamination removed prior to it reaching the projectors clean air supply. Devices or structures to extract or shield contaminated air well away from the projector are a prerequisite, if this is not a feasible solution then measures to relocate the projector to a clean air environment should be considered. Make sure that the projector never runs with dirty dustfilters as this will dramatically reduce the lifetime of the consumables. It is advised to clean the dustfilters on a regular basis and to replace them at any lamp change. Barco reserves itself the right to refuse warranty replacement of consumables if they have been used in a projector with dirty airfilters. Only use the manufactures recommended cleaning kit which

3. Installation Guidelines

has been specifically designed for cleaning optical parts, never use industrial strength cleaners on a projectors optics as these will degrade optical coatings and damage sensitive optoelectronics .

Failure to take suitable precautions to protect the projector from the effects of persistent and prolonged air contaminants will culminate in extensive and irreversible ingrained optical damage. At this stage cleaning of the internal optical units will be non-effective and impracticable. Damage of this nature is under no circumstances covered under the manufactures warranty and may deem the warranty null and void. In such a case the client shall be held solely responsible for all costs incurred during any repair. It is the clients responsibility to ensure at all times that the projector is protected from the harmful effects of hostile airborne particles in the environment of the projector. The manufacture reserves the right to refuse warranty repair if a projector has been subject to wantful neglect, abandon or improper use.

What about ambient light ?

The ambient light level of any room is made up of direct or indirect sunlight and the light fixtures in the room. The amount of ambient light will determine how bright the image will appear. So, avoid direct light on the screen. Windows that face the screen should be covered by opaque drapery while the set is being viewed. It is desirable to install the projection system in a room whose walls and floor are of non-reflecting material. The use of recessed ceiling lights and a method of dimming those lights to an acceptable level is also important. Too much ambient light will 'wash out' of the projected image. This appears as less contrast between the darkest and lightest parts of the image. With bigger screens, the 'wash out' becomes more important. As a general rule, darken the room to the point where there is just sufficient light to read or write comfortably. Spot lighting is desirable for illuminating small areas so that interference with the screen is minimal.

Which screen type ?

There are two major categories of screens used for projection equipment. Those used for front projected images and those for rear projection applications. Screens are rated by how much light they reflect (or transmit in the case of rear projection systems) given a determined amount of light projected toward them. The 'GAIN' of a screen is the term used. Front and rear screens are both rated in terms of gain. The gain of screens range from a white matte screen with a gain of 1 (x1) to a brushed aluminized screen with a gain of 10 (x10) or more. The choice between higher and lower gain screens is largely a matter of personal preference and another consideration called the Viewing angle. In considering the type of screen to choose, determine where the viewers will be located and go for the highest gain screen possible. A high gain screen will provide a brighter picture but reduce the viewing angle. For more information about screens, contact your local screen supplier.

Image size

The projector is designed for projecting an image size with a screenwidth from 1.00m (3.3ft) to 6.00m (19.7ft) with an aspect ratio of 4 to 3.

3.3 Projector configurations

The different configurations

The MGP can be installed in either a single or dual projector configuration..

The MGP projector can be operated in either Portrait or Landscape mode.

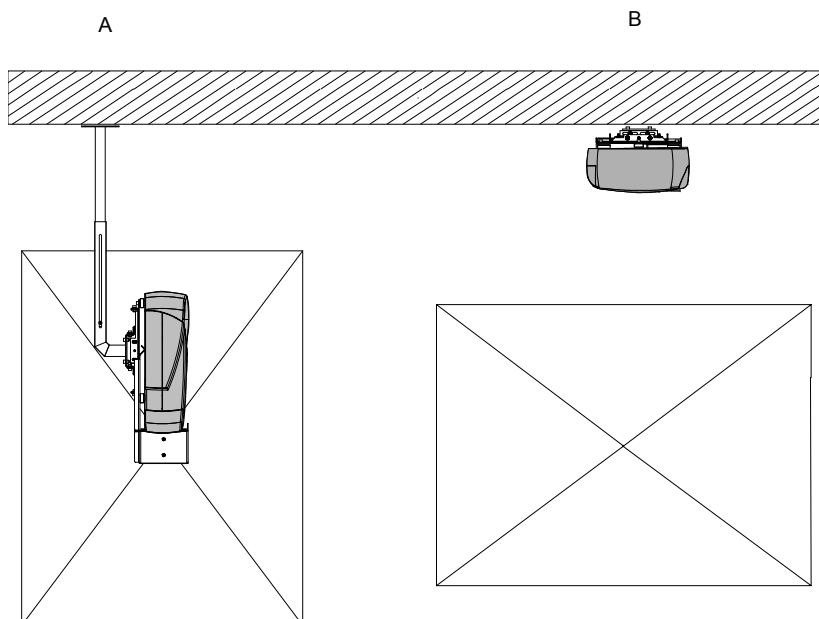

Image 3-1

- A portrait mode
- B landscape mode



Refer to the Installation manual for more info on how to install the ceiling mounts

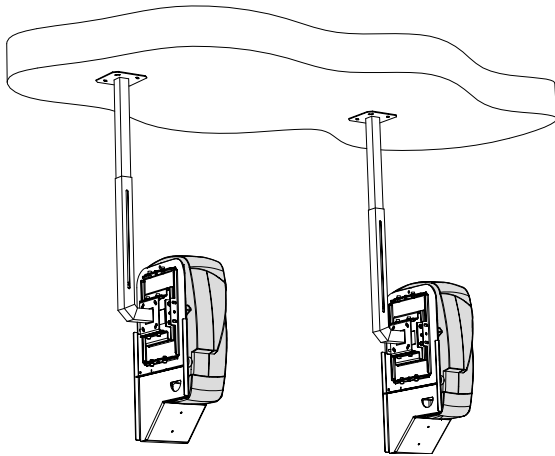

Image 3-2
Dual head setup in portrait mode



Lens range to be used in combination with the MGP Ceiling mount Kit for front projection: SVD (2.0 - 2.5)

Only on axis projection since vertical shift is impossible (vertical shift becomes horizontal shift).

Rear projection is also possible within a dedicated rear structure.

For the landscape viewing mode one can define the standard projector configurations:

1. Rear/Ceiling
2. Rear/Table
3. Front/Ceiling
4. Front/Table

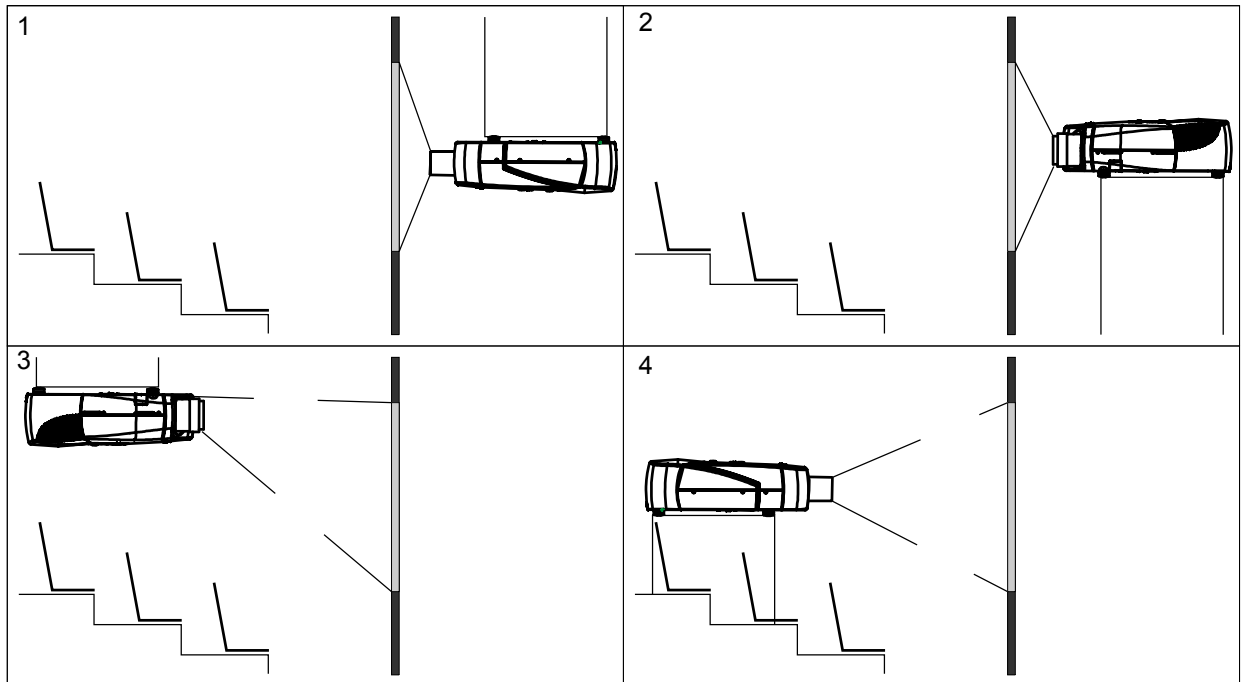

Image 3-3

Positioning the projector

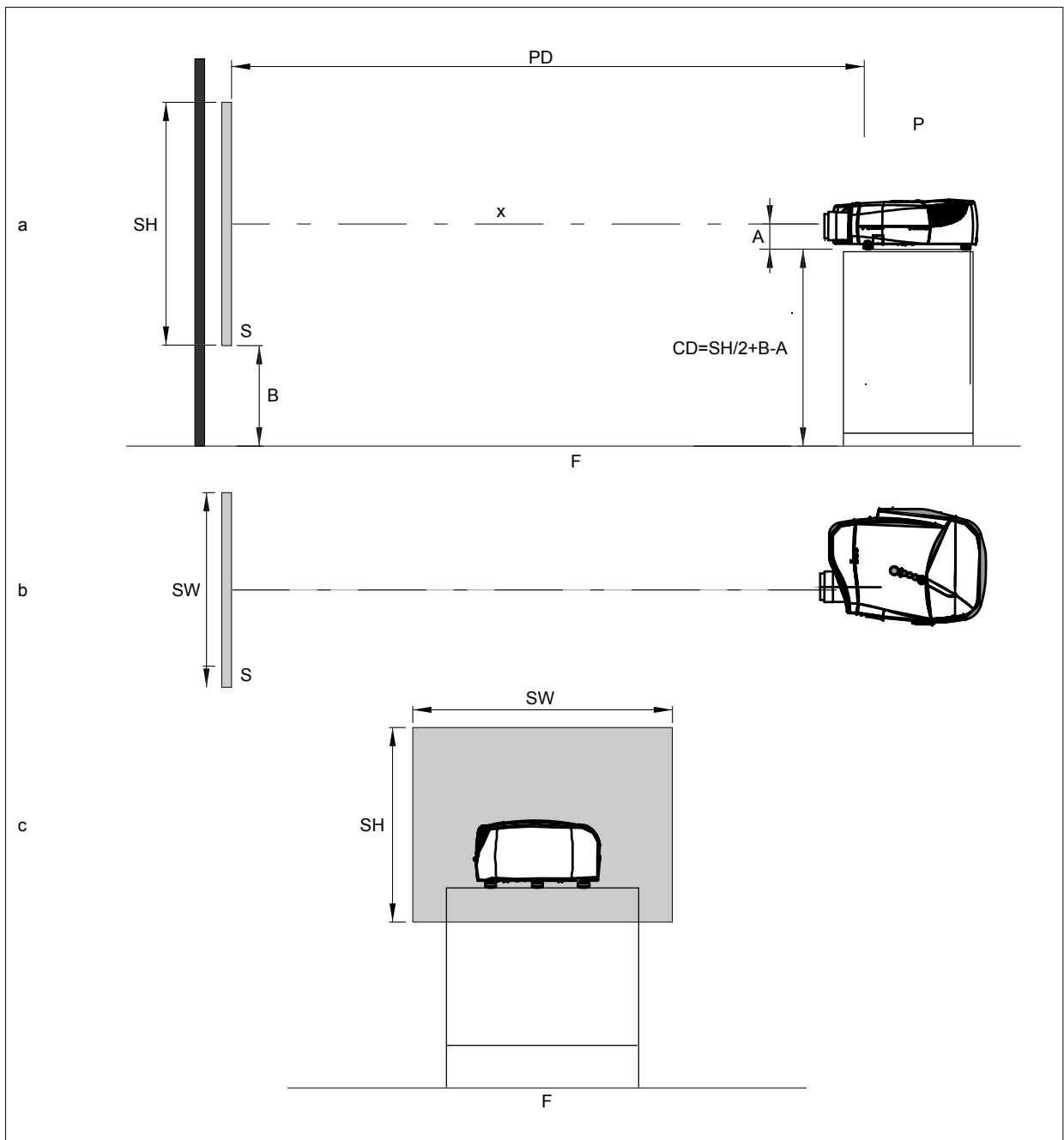

Image 3-4
ON-Axis installation

- a side view
- b top view
- c back view
- x optical axis projection lens
- p projector
- s screen
- F floor

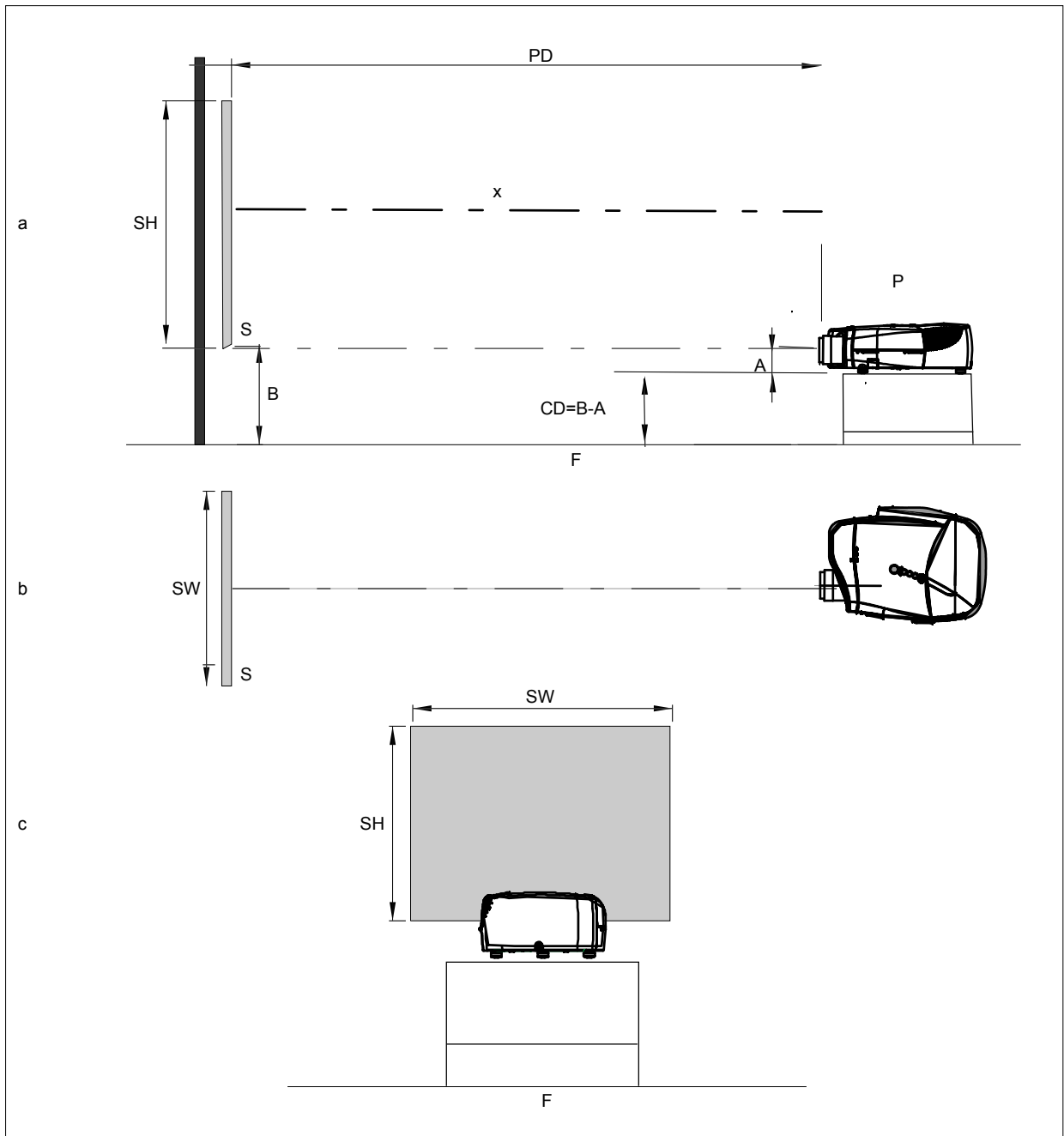

Image 3-5
100% OFF Axis installation

- a side view
- b top view
- c back view
- x optical axis projection lens
- p projector
- s screen
- F floor

3.4 Lenses

Overview

- Lenses
- Lens formulas
- Lens installation
- Removing the lens
- Cleaning the lens

3.4.1 Lenses

Available lenses

The following lenses are available, or will become available (contact a BARCO service center) as an option :

Lenses	Standard version
QVD(0.85:1)	R9841220
QVD(1.3-1.8:1)	R9840950
QVD(1.9-2.6:1)	R9840960
QVD(3.0-6.0:1)	R9840970
QVD(7:1)	R9841230
SVD(2.0-2.5:1)	R9841240



The QVD (0.85:1) is to be used in ON Axis configuration only.
Shifting the lens vertically will not guarantee optimal image quality.

3.4.2 Lens formulas

Formulas

	Metric Formulas (meter)	Inch formulas (inch)
QVD(0.85:1)	$PD = -0.034 + 0.801 \times SW + 0.0086 / SW$	$PD = -1.34 + 0.801 \times SW + 13.35 / SW$
QVD(1.3-1.8:1)	$PD_{min} = 0.019 + 1.216 \times SW + 0.028 / SW$ $PD_{max} = -0.001 + 1.584 \times SW + 0.074 / SW$	$PD_{min} = 0.75 + 1.216 \times SW + 43.4 / SW$ $PD_{max} = -0.04 + 1.584 \times SW + 115 / SW$
QVD(1.9-2.6:1)	$PD_{min} = 0.052 + 1.731 \times SW - 0.014 / SW$ $PD_{max} = 0.11 + 2.33 \times SW - 0.059 / SW$	$PD_{min} = 2.05 + 1.731 \times SW - 21.7 / SW$ $PD_{max} = 4.33 + 2.33 \times SW - 91.8 / SW$
QVD(3.0-6.0:1)	$PD_{min} = 0.048 + 2.795 \times SW - 0.042 / SW$ $PD_{max} = 0.06 + 5.6 \times SW - 0.041 / SW$	$PD_{min} = 1.89 + 2.795 \times SW - 65 / SW$ $PD_{max} = 2.36 + 5.6 \times SW - 63.4 / SW$
QVD(7:1)	$PD = 0.013 + 6.35 \times SW + 0.005 / SW$	$PD = 0.51 + 6.35 \times SW + 8.35 / SW$
SVD(2.0-2.5:1)	$PD_{min} = -0.139 + 1.733 \times SW + 0.1 / SW$ $PD_{max} = 0.005 + 2.224 \times SW - 0.00862 / SW$	$PD_{min} = -5.47 + 1.733 \times SW + 153 / SW$ $PD_{max} = 0.2 + 2.224 \times SW - 13.3 / SW$



Lens program to calculate the projector distance is available on the BARCO web site : http://www.barco.com/projection_systems/customer_services/lens_program.asp

3.4.3 Lens installation

How to install ?

1. Take the lens out of its packing material
2. Slide the lensdoor to the left (image 3-6)
3. Fix the lens by placing it in the housing
Note: In case of a motorized lens the female jack must be in front of the male jack located in the upper-left part of the housing in the projector (image 3-7)
4. Push carefully to lock the lens in the housing
5. Slide back the lensdoor to the right



Image 3-6



Image 3-7

3.4.4 Removing the lens

How to remove the lens ?

1. Slide the lens door to the left.
2. Unlock the lens by pulling the handle located on the right side of the projector (image 3-8)
3. Remove the lens out of its housing



Image 3-8



CAUTION: Never transport the projector with the lens mounted on it !
Always remove the lens before transporting the projector.

3.4.5 Cleaning the lens



To minimize the possibility of damaging the optical coating or scratching exposed lens surface, we have developed recommendations for cleaning the lens. **FIRST**, we recommend you try to remove any material from the lens by blowing it off with clean, dry deionized air. **DO NOT** use any liquid to clean the lenses.

Necessary tools

Toraysee™ cloth (delivered together with the lens kit). Order number : R379058.

How to clean the lens ?

Proceed as follow :

1. Always wipe lenses with a CLEAN Toraysee™ cloth.
 2. Always wipe lenses in a single direction.
Warning: Do not wipe back and forwards across the lens surface as this tends to grind dirt into the coating.
 3. Do not leave cleaning cloth in either an open room or lab coat pocket, as doing so can contaminate the cloth.
 4. If smears occur when cleaning lenses, replace the cloth. Smears are the first indication of a dirty cloth.
-



WARNING: Do not use fabric softener when washing the cleaning cloth or softener sheets when drying the cloth.

Do not use liquid cleaners on the cloth as doing so will contaminate the cloth.



CAUTION: Other lenses can also be cleaned safely with this Toraysee™ cloth.

3.5 Batteries

Overview

- Battery installation

3.5.1 Battery installation

How to install the battery

Two batteries are packed together with the RCU. Before using your RCU, install first these batteries.

1. Remove the battery cover on the backside by pushing the handle a little towards the bottom of the RCU.
2. Lift up the top side of the cover at the same time.
3. Insert the batteries as indicated in the RCU.
4. Put the battery cover on its place.

4. CONNECTIONS

4.1 Power connection

AC power (mains) cord connection

Use the supplied power cord to connect your projector to the wall outlet.

Plug the female power connector into the male connector at the front of the projector.



The power input is auto-ranging from 90 to 240 VAC.

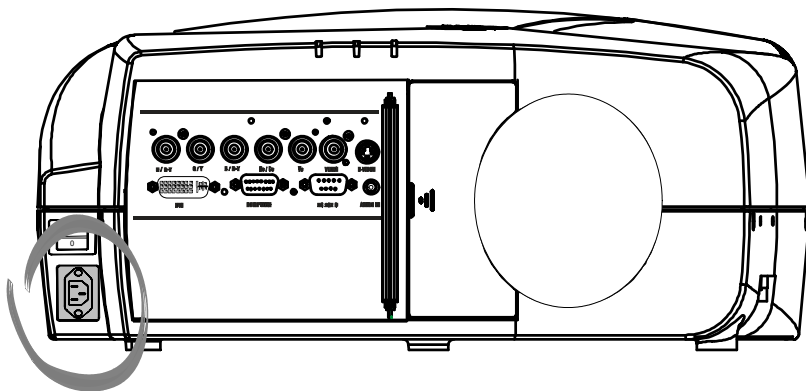

Image 4-1

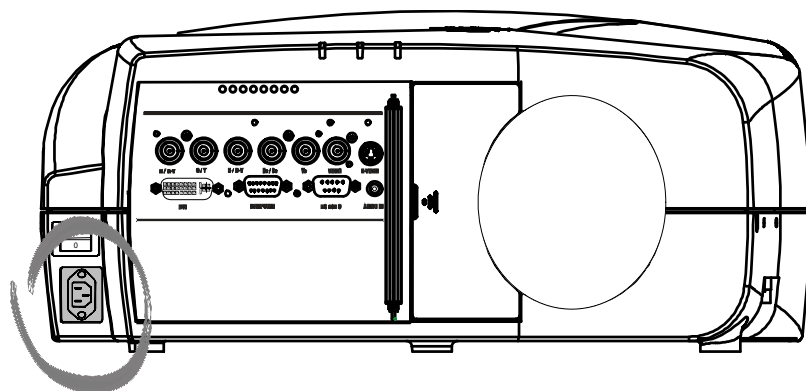

Image 4-2

Fuses

For continued protection against fire hazard :

- refer replacement to qualified service personnel
- ask to replace with the same type of fuse.

4.2 Input Source connections

Overview

- Input section
- Input facilities
- 5-Cable input
- Composite Video Input
- S-Video input
- Digital Visual Interface (DVI) input
- Computer input

4.2.1 Input section

Input Layers

The input section is divided in layers, each of them regrouping several inputs, this architecture allows the input section to be upgraded at any time with an optional analog or digital layer.

1. Layer 1: analog layer containing analog data and video inputs
2. Layer 2: a hybrid layer containing 2 digital and 1 analog input

4.2.2 Input facilities

overview

- 5-cable input
- composite video
- component video (PR/Y/PB)
- S-Video
- Digital Visual Input (DVI)
- Computer

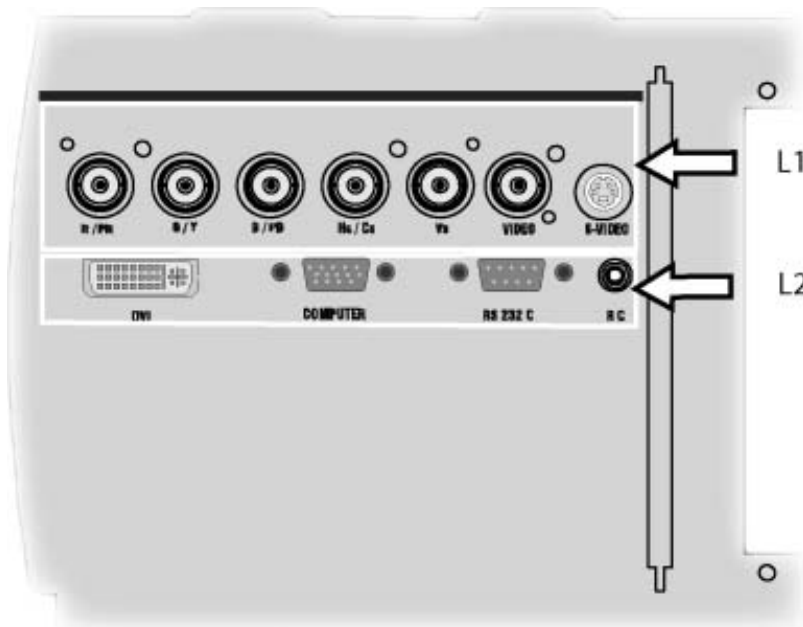

Image 4-3

4.2.3 5-Cable input

Input specifications

The 5-cable input section is made of 5 BNC input terminals.

0.7 V_{pp} ± 3dB

75 Ω terminated

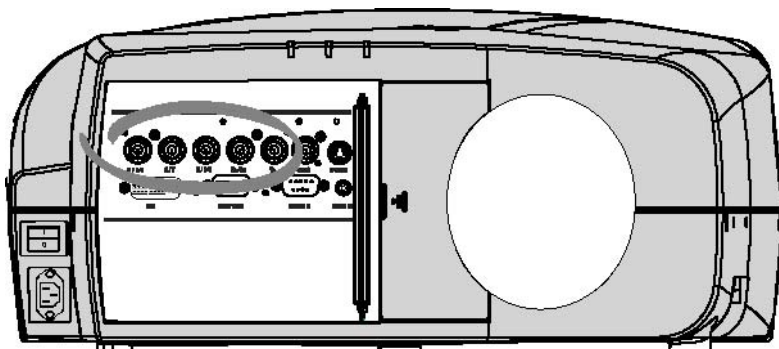

Image 4-4



Component Video

In Component Video the term component describes a number of elements that are needed to make up the video picture, these components are PR/Y/PB. A composite video signal on the other hand contains all the information needed for the color picture in a single channel of information

Which signals can be connected ?

Signals/Input BNC	R	G	B	H	V
RGBHV	R	G	B	H	V
RG _s B ¹	R	G _s	B	-	-
RGBS ¹	R	G	B	S	-
Component	PR	Y	PB	-	-

How to select a source on the 5 cable input ?

1. Press 1 on the RCU

Note: Another way for selecting this input is via **Source** on the local keypad or via the Menu

4.2.4 Composite Video Input

Input specifications

The Composite video input section is made of 1BNC input terminal.

1.0 Vpp ± 3dB

75 Ω terminated

No loop through

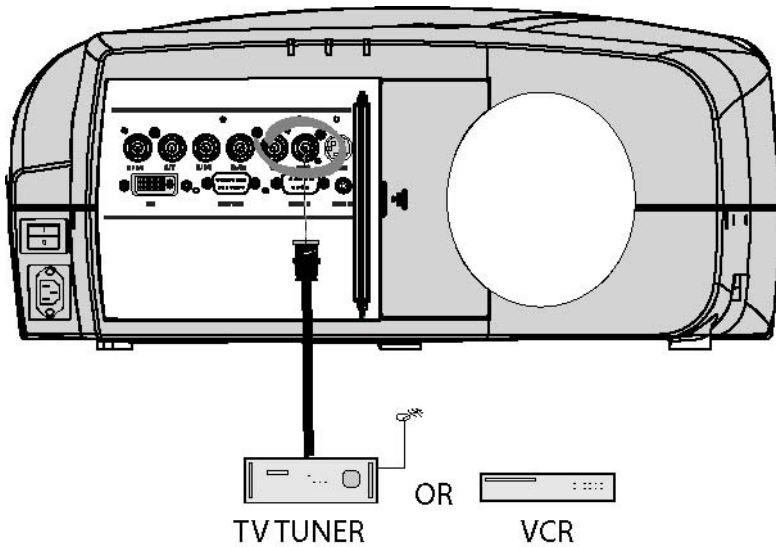

Image 4-5

How to select a Composite Video Input ?

1. Press **3** on the RCU

Note: Another way for selecting this input is via **Source** on the local keypad or via the Menu.

4.2.5 S-Video input

Input specification

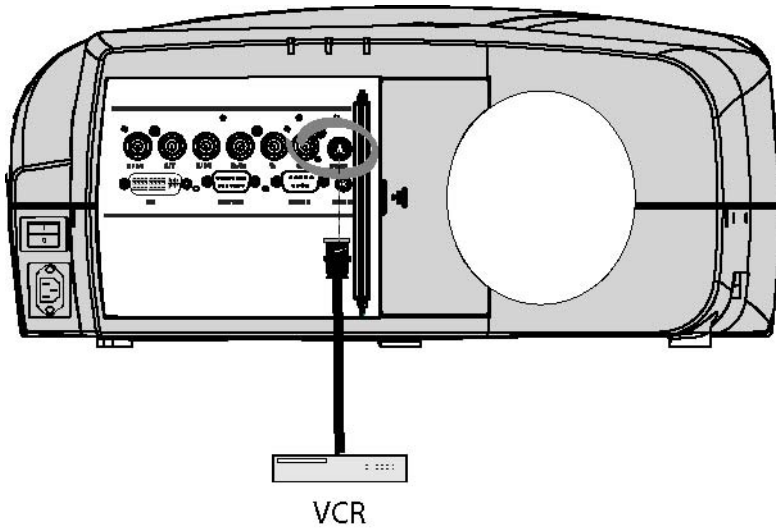

Image 4-6

Which signal can be connected ?

Standard S-Video (S-VHS) with separate Y(luma) and C (chroma) signals.

How to select the S-Video input ?

1. Press **4** on the RCU

Note: Another way for selecting this input is via **Source** on the local keypad or via the Menu.

4.2.6 Digital Visual Interface (DVI) input



DVI

Digital Visual Interface is a display interface developed in response to the proliferation of digital flat panel displays.

The digital video connectivity standard that was developed by DDWG (Digital Display Work Group). This connection standard offers two different connectors: one with 24 pins that handles digital video signals only, and one with 29 pins that handles both digital and analog video. This standard uses TMDS (Transition Minimized Differential Signal) from Silicon Image and DDC (Display Data Channel) from VESA (Video Electronics Standards Association).

DVI can be single or dual link.

Input specifications

Single link DVI

Differential input voltage: 200 mV - 800mV

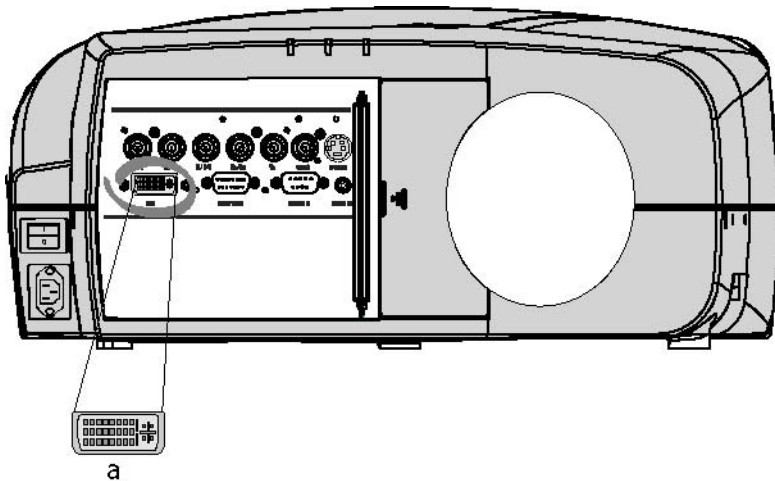

Image 4-7

- a DVI-I type connector analog link (4 pins at the right side of the connector) not supported

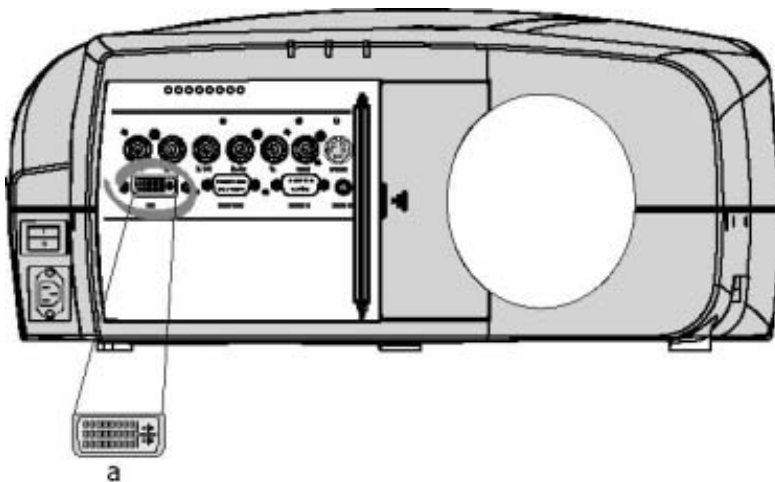

Image 4-8

How to select the DVI Input ?

1. Press **5** on the RCU

Note: Another way for selecting this input is via the Menu.

4. Connections

4.2.7 Computer input

Input specification

TTL sync input : $U_{\min} = 2.0 \text{ V}$

RGB input = $0.7 \text{ V}_{\text{pp}} \pm 3\text{dB}$

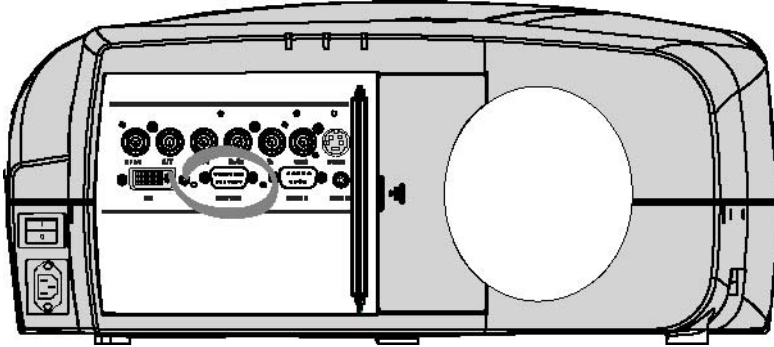

Image 4-9

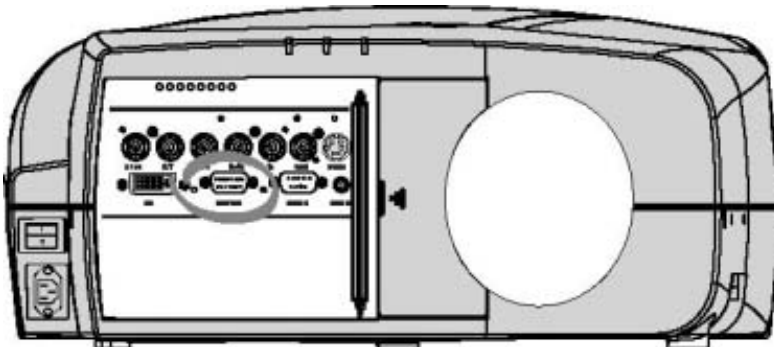

Image 4-10

What can be connected ?

- RGBHV
- RG_SB



Composite sync only possible on Green

How to select a computer input ?

1. Press 2 on the RCU

Note: Another way for selecting this input is via the Menu.

4.3 Communications Connections

Overview

- RS232 IN connection

4.3.1 RS232 IN connection

What can be connected to the RS232 IN connection ?

The RS 232 IN connections allows the projector to communicate with a Computer e.g. IBM PC or Apple Macintosh.

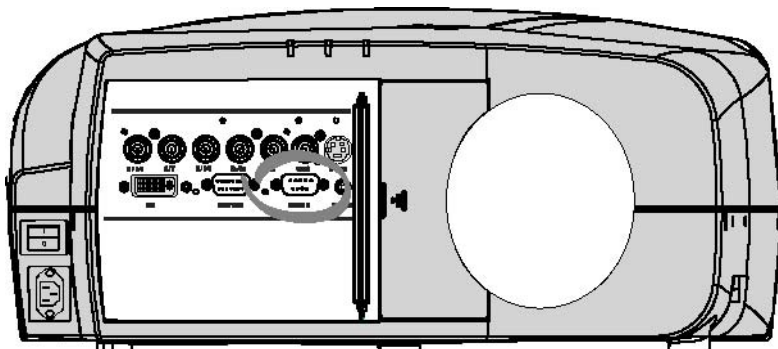

Image 4-11

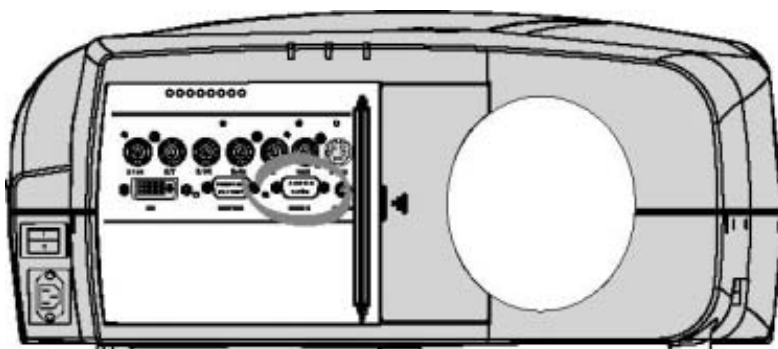

Image 4-12

Applications of the RS232 connection

Remote control:

- easy adjustment of projector via IBM PC (or compatible) or MAC connection.
- address range from 1 to 255
- allow storage of multiple projector configurations and set ups.
- wide range of control possibilities

Data communication: sending data to the projector or copying the data from the projector to the computer



To set up the baudrate of the projector, see the Installation menu

4.4 Connecting the MGP in Dicom Theatre®

Which connections are made ?

The MGP is connected to the MediCal® Pro system through :

- serial communication via the RS232 IN port
- signal connection through the RGB data and/or D15 PC input



Connecting to both RGB and D15 PC is possible and will allow simultaneous display in Picture in Picture mode, this can be useful for comparative purposes.

4. Connections

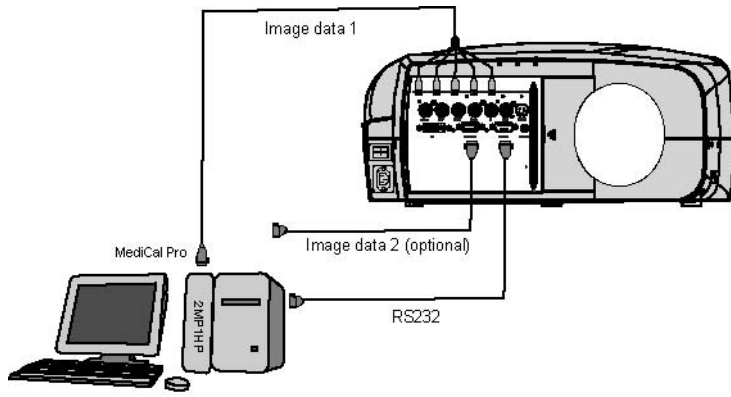

Image 4-13

5. GETTING STARTED

Overview

- Quick startup
- RCU & Local keypad
- Terminology overview
- Switching on
- Lamp runtime
- Quick set up adjustments
- Projector address
- Digital Zoom
- Menu structure
- Using the menu
- Using the Dialogboxes

5.1 Quick startup

The executive RCU

The executive RCU is used for quick access and allows basic control over the projector.

Dual head setup

In a dual head setup, the two projectors are default programmed with respectively projector address 1 and 2.

In order to control the right projector, the executive RCU has to be programmed with the right address.

This is done by pressing the numeric key 1 or 2 depending on the projector to be controlled.

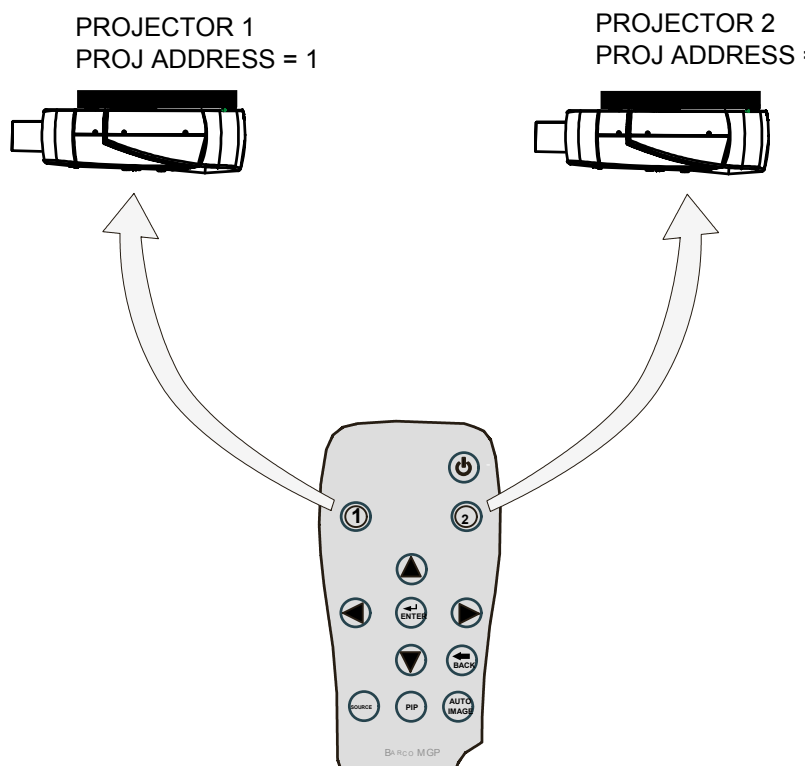

Image 5-1



**In case of a single projector setup the projector should respond to address 1.
Otherwise, set the projector address to 1 in the *Installation* menu.**

Select a projector

1. Push 1 or 2 to select projector 1 or 2 (image 5-2)

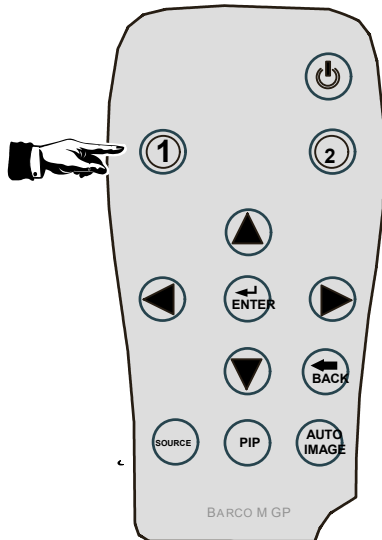

Image 5-2

Turn the projector on

1. Push the standby button on the executive RCU (image 5-3)

It takes about a minute before the projector displays the identification screen (if enabled)

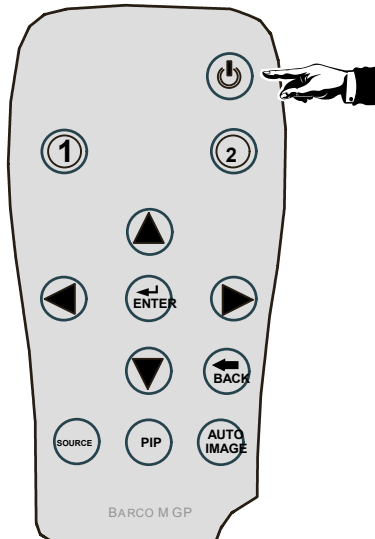

Image 5-3



If the projector doesn't go in operational mode verify that the main power switch is in the ON position (see Connections)

Select a source

1. Push the **source** button (image 5-4)

Each key press moves to the next source.

A box is displayed in the lower part of the image indicating the selected source.

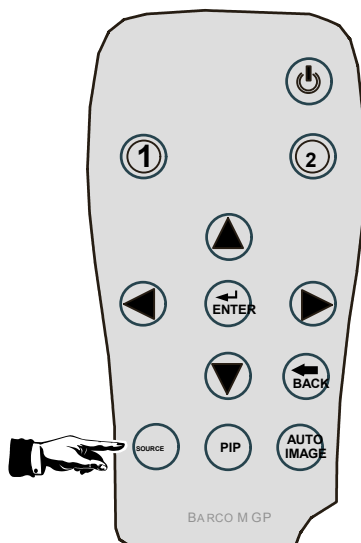

Image 5-4

The image is not stable or is disformed : Autolmage

1. Push the Autolmage button on the executive RCU (image 5-5)

The projector shows the evolution of the AutoSetup operation in a dialogbox.

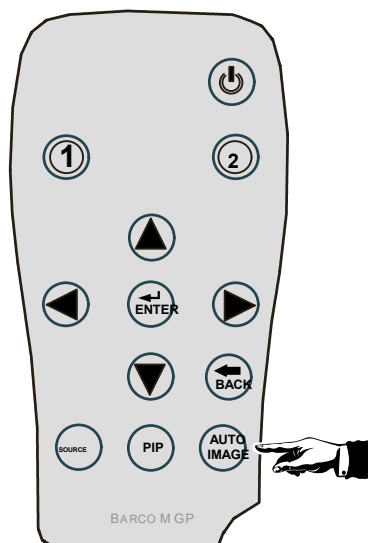

Image 5-5



Depending on the *Autosetup* setting in the menu, the operation may take a few seconds or minutes.

5.2 RCU & Local keypad

How controlling the projector ?

The projector can be controlled by the local keypad or by the remote control unit.

Location of the local keypad ?

The local keypad is located on the topside of the projector.

5. Getting started

For key overview: "Terminology overview", page 31

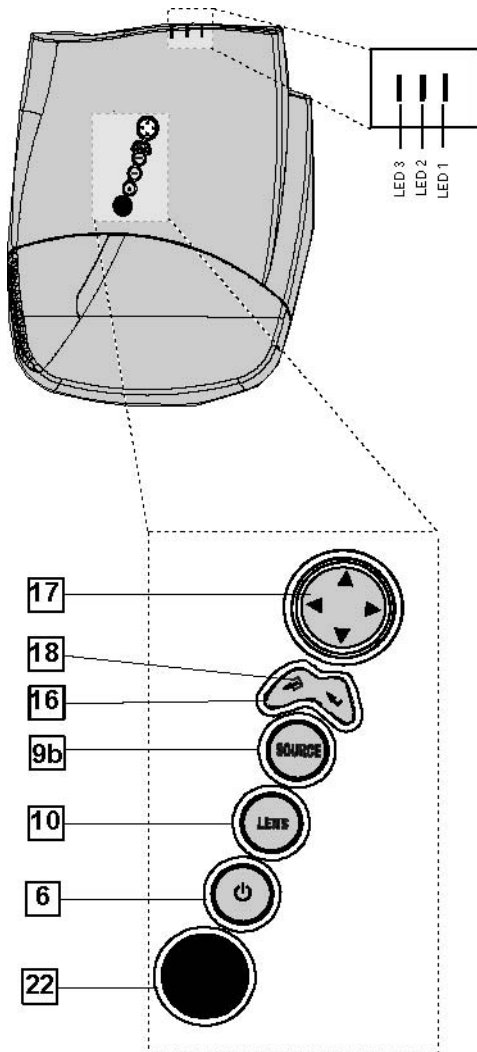

Image 5-6
Local keypad layout

Remote control functions.

This remote control includes a battery powered infrared (IR) transmitter that allows the user to control the projector remotely. This remote control is used for source selection, control, adaptation and set up. It includes automatic storing of picture controls (Brightness, Sharpness...) and settings.

Other functions of the remote control are :

- switching between stand by and operational mode.
- switching to "pause" (blanked picture, full power for immediate restarting)
- direct access to all connected sources.

Diagnose LED's

	Green	Red
LED1	cool down sequence: flickers 60 seconds (120 seconds in case of 400 series) after switching to standby	rescue program (software error)
LED2	only for iQ Pro: shows when projector is in standby and server is actif.	hardware error
LED3	IR acknowledgement	continue : standby flickers : Security = ON

5.3 Terminology overview

Overview

The following table gives an overview of the different functionalities of the keys.

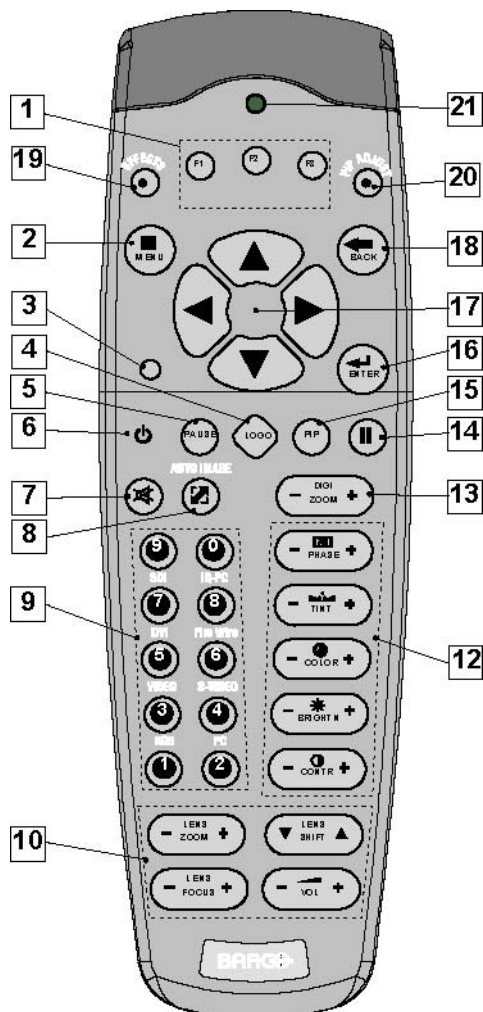

Image 5-7

1	Function keys	user programmable keys with functions for direct access.
2	MENU	Menu key, to enter or exit the Toolbar menu.
3	Address key	(recessed key), to enter the address of the projector (between 0 and 9). Press the recessed address key with a pencil, followed by pressing one digit button between 0 and 9.
4	LOGO key	allows to recall the stored Logo (not in PiP mode)
5	PAUSE	to stop projection for a short time, press 'PAUSE'. The image disappears but full power is retained for immediate restarting.
6	STBY	standby button, to start projector when the power switch is switched on and to switch off the projector without switching off the power switch. Attention : Switching to Standby. When the projector is running and you want to go to standby, press the standby key for 2 seconds.
7	MUTE	to interrupt the sound reproduction (audio = optional).
8	AUTOIMAGE	Auto image, to center the image on the active LCD surface.
9	Digit buttons	direct input selection.
9b	SOURCE button	this button allows to switch through the active (scanned) inputs

5. Getting started

10	Lens control	use these buttons to obtain the desired ZOOM, SHIFT, FOCUS.
11	VOL	use this button to obtain the desired sound level (audio = optional)
12	Picture controls	use these buttons to obtain the desired picture analog level.
13	DIGI ZOOM	allows a digital Zoom of a part of the image
14	FREEZ	press to freeze the projected image.
15	PIP	allows to activate the PICTURE IN PICTURE mode
16	ENTER	to confirm an adjustment or selection in the MENU. On the local keypad the ENTER button additionally accesses the PIP window resize function
17	Cursor keys	Cursor Keys on RCU or on the local keypad : to make menu selections or to access the toolbar.
18	BACK	to leave the selected menu or item (go upwards to previous menu).
19	EFFECTS	not yet implemented
20	PIP ADJUST	allows to select a PiP window and change its configuration on screen
21	RC operating indication	lights up when a button on the remote control is pressed. (This is a visual indicator to check the operation of the remote control)
22	IR receiver	IR receiver

Table 5-2



ordernumber RCU: R763794K

5.4 Switching on

How to switch on.

1. Press the power switch to switch on the projector.
 - When '0' is pushed in, the projector is switched off.
 - When '1' is pushed in, the projector is switched on

The projector starts in standby mode, LED3 is red.

Starting image projection.

1. Press **Standby** key once on the local keypad or on the remote control.



It may take about 60 seconds before image projection, i.e. no projection until the completion of several operations (software initialization,...).



If the Security mode is enabled, a textbox will be displayed for PIN code entry, see **Security** setting in the **Installation** menu

5.5 Lamp runtime

Lamp runtime indication while running

Independently of the lamp mode, when the total runtime of an active lamp (lamp1 for example) is 1470 hours or more, a warning message will be displayed.

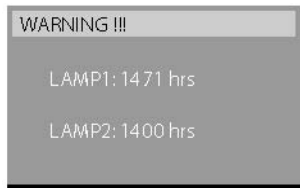

Image 5-8
warning message in case of an MGP 10 projector

This warning message will be repeated at the next start up. Press **BACK** or **MENU** to remove the message.

The total lifetime of the lamp for a safe operation is 1500 hours max, do not use it longer. Always replace with a same type of lamp. Call a BARCO authorized service technician for lamp replacement.

When the lamp runtime reaches 1500 hours the projector switches automatically to the other lamp, being lamp2.. following messages are displayed during and after switching.

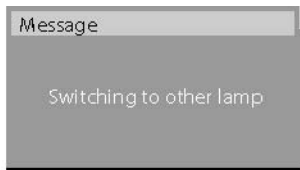

Image 5-9

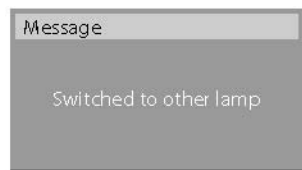

Image 5-10

When lamp2 at its turn reaches 1470 hours, a warning message appears on the screen.

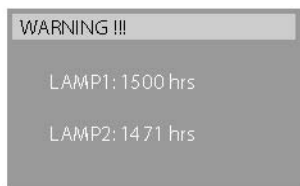

Image 5-11
warning message in case of a MGP 10 projector

At the end of the lifetime of lamp2 (**1500** hours) the projector generates an alert message.

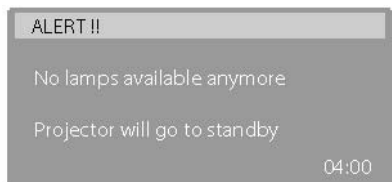

Image 5-12

A countdown time of 4 minutes is triggered before the projector is shut down (standby).

If the lamp runtime has not been reset, the alert message will reappear at the next start up (with again 4 minutes countdown time).

This alert message can be escaped with **MENU** or **BACK**, but the countdown continues.

Contact a qualified Barco technician for lamp replacement.



In Dual mode the lamp end of lifetimes are reached at the same time, however if in dual lamp mode one lamp has been used more than the other (for example if the projector has been working temporarily in single mode), one lamp will reach its end of lifetime sooner than the other lamp, which brings us to the Single mode operation.

5.6 Quick set up adjustments

Overview

- Quick lens Adjustment
- Using the RCU

5.6.1 Quick lens Adjustment

What can be done ?

For a quick lens set up and image shift, use the RCU dedicated keys or the lens button on the local keypad



Zoom/focus are only available for motorized lenses.

Quick zoom/focus adjustment

1. Press **LENS ZOOM** or **LENS FOCUS** on the RCU
2. Use the arrow keys to adjust

Quick shift adjustment

1. Press **LENS SHIFT**
2. Use the arrow keys to adjust

5.6.2 Using the RCU

Pointing to a reflective screen

1. Point the front of the RCU to the reflective screen surface. (image 5-13)

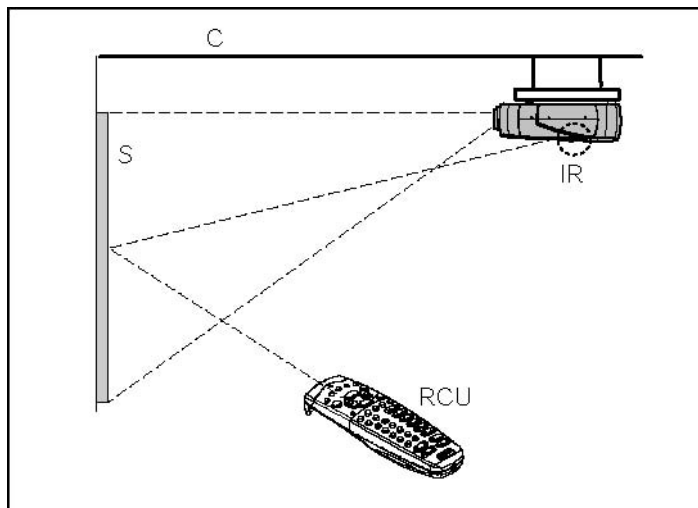

Image 5-13



When using the remote control, make sure you are within the effective operating distance.

The operating distance may be up to 15 m (50ft).



The remote control unit will not function properly if strong light strikes the sensor window or if there are obstacles between the remote control and the IR sensor.

How to connect ?

1. Plug one end of the remote cable in the connector on the bottom of the RCU.
2. Plug the other end in the connector in the front panel of the projector labelled **RC**. (image 5-14)

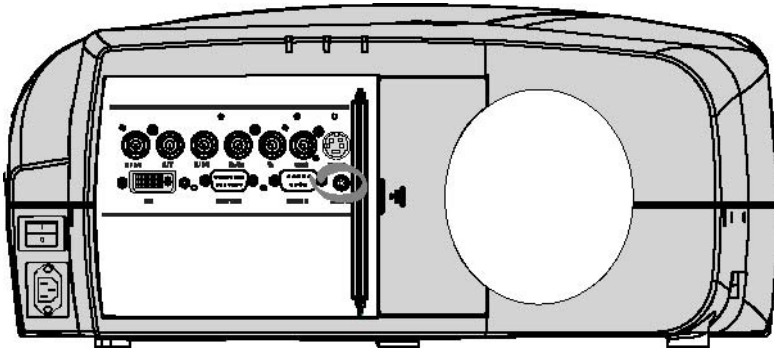

Image 5-14

Specifications of the RC input

$U_{in} = 9V$

$I_{max} = 80 \text{ mA}$

Internal IR receivers can be disabled:

- mono jack : on plug in of the jack
- stereo jack : on plug in or using an external switch bringing the right channel (B) to ground level.

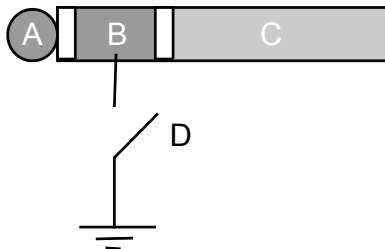

Image 5-15
Stereo jack pin configuration

- A tip: Left channel
- B ring: right channel
- C screen: common (GND)
- D external switch



The Remote connection uses a standard two wire cable terminated on each end with a 3.5 mm male (mono/stereo) phone jack.

This cable is not delivered but is available in most electrical or audio shops.

5.7 Projector address

Overview

- Address setting
- Displaying and Programming addresses into the RCU

5.7.1 Address setting



Projector address

Address installed in the projector to be individually controlled.



Common address

Default address. Projector will always execute the command coming from a RCU programmed with that common address.

Why a projector address ?

As more than one projector can be installed in a room, the separate projector should be separately addressable with an RCU or computer. Therefore each projector has its own address.

Set up an individual Projector Address.

The set up of a projector address can be done via the software.

Projector controlling.

Every projector requires an individual address between 0 and 255 which can be set in the *Installation* menu.

When the address is set, the projector can be controlled by :

- RCU for addresses between 0 and 9.
- computer, e.g. IBM PC (or compatible), Apple MAC, etc. for addresses between 0 and 255.

A projector will respond to a RCU set to the common address '0' regardless of what address is set in the projector itself (common address of projector should also be "0").

The RCU is default programmed with address 0 , 'common address'.



If it is necessary to control a specific projector, then enter the projector address into the RCU (only when that address is between 0 and 9). The projector with the corresponding address will listen to that specific RCU.



Some projectors may operate in domestic environments where other equipments may listen to the common address "0" , therefore the common address can also be set to "1".

5.7.2 Displaying and Programming addresses into the RCU

Displaying the Projector Address on the Screen.

1. Press the **Address** key (recessed key on the RCU) with a pencil.

The projector's address will be displayed in a 'Text box'



To continue using the RCU with that specific address, it is necessary to enter the same address with the digit buttons (address between 0 and 9) within 5 seconds after pushing the address key. For example : if the Address key displays projector address 003, then press "3" digit button on the RCU to set the RCU's address to match the projector's address. Do not press 0-0-3 . This will address the remote control to '0' and control all projectors in the room. If the address is not entered within 5 seconds, the RCU returns to its default address (zero address) and controls then all projectors in the room.

Address 0 (or 1) should always allow communication with the projector since it is a common address.

Displaying the Projector Address in Standby.

1. Press the **Address** key (recessed key on the RCU) with a pencil.

All the LED's on the front of the projector go out.

Then LED1 starts blinking green the number of hundreds. After that LED2 starts blinking the number of tens. Finally LED3 starts blinking green the number of units. If this is done, the original status of the leds is restored.

5.8 Digital Zoom

What can be done ?

The Digital Zoom key on the RCU allows to zoom (in or out) one particular part of the image

How to Zoom ?

1. Press ← or → on the **Digital Zoom** key on the remote to Zoom the center of the image

A wizardbox is displayed in the lower part of the screen, follow the instructions.

Use the **BACK** key to undo the Zoom function.



Digital Zoom can not be performed on a logo.

5.9 Menu structure

PC like menustructure

The projector has a built in "PC like" toolbar menu which allows easy access to different parameters for setting up the projector.

The menu is activated by pressing **MENU**, it contains 2 levels depending on the type of user:

- Level 1: standard user
- Level 2: advanced user, level 2 is password protected, the advanced parameters are only visible when the correct password has been entered (factory password = "0000")



Menu items which are not applicable are greyed out.

5.10 Using the menu

Menu Layout

A grey line gives the transition between standard and advanced parameters.

The existence of a submenu is indicated by a white arrow, *Aspect ratio* is a submenu.

Contrast is an item of the *Adjustment* menu.

Three suspension points indicate that the menuitem hides a dialogbox or a textbox.

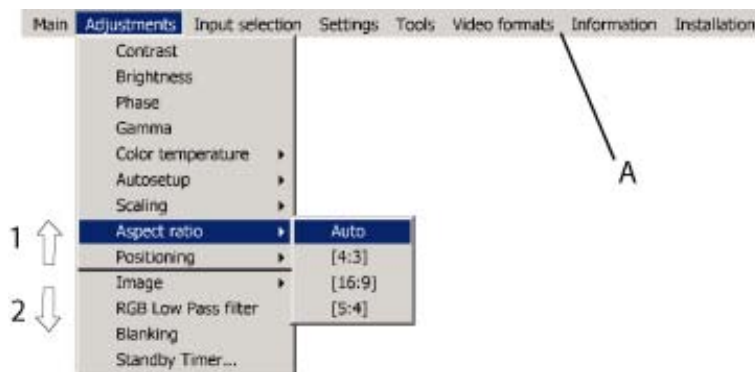

Image 5-16



The menus inserted in this manual are of the advanced type: all the items are visible. The menu seen by a standard user on the screen will hence not correspond with the menu in the manual i.e. the advanced items will not be visible, they will be replaced with "More..."



Greyed out menus or items are not available in this software version

How to pull down a menu ?

1. Use ↓ to pull down a menu

How to pull down a submenu ?

1. Use → to pull down a submenu

How to exit the submenu ?

1. Press **BACK** to exit a submenu



Press **MENU** to exit the menu



When the menu has been exited for more than 1 minute, the advanced user password has to be re-entered.

5.11 Using the Dialogboxes

How to use the dialogboxes ?

Some parameters are modified by means of a dialogbox, where selections can be made and/or values can be entered, The values can be entered in several ways:

Entering numeric values using the numeric keys on the remote control

1. Press **ENTER** to activate the input field (image 5-17)
2. Key in the desired value

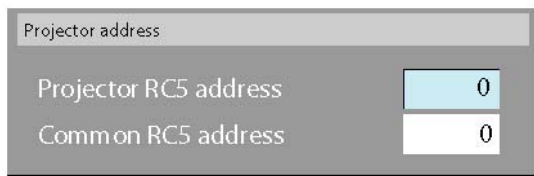

Image 5-17

Entering numeric values using the arrow keys on the remote control

1. Press **ENTER** to activate the input field.
2. Press ← or → to select the digit to be changed (image 5-18)
3. Press ↓ or ↑ to increase or decrease the value



Image 5-18

Entering numeric values using the arrow keys on the local keypad

1. Press **ENTER** to activate the input field.
2. Press ← or → to select the digit to be changed
3. Press ↓ or ↑ to increase or decrease the value



To confirm the changes always press **ENTER**.

Use ↓ or ↑ to browse between the different fields.



In some cases an alphanumeric value (file name, ...) has to be entered. Use ↑ or ↓ to scroll through the character values once the input field is activated

Following characters can be browsed in this particular order:

Decimal scroll list: 0123456789

Signed decimal scroll list: 0123456789-

ASCII scrolllist:ABCDEFGHIJKLMNOPQRSTUVWXYZ0123456789+*/&@#.;:abcdefghijklmnopqrstuvwxy

6. INTRODUCTION TO MEDICAL VISUALIZATION SYSTEMS



DICOM

Digital Imaging and Communications in Medicine

It is a standard developed by the American College of Radiology (ACR) and the National Electrical Manufacturers Association (NEMA). The standard specifies how digital image data can be moved from system to system. In addition, Supplement 28 Part 14 specifies a function that relates pixel values to displayed Luminance levels and is called Grayscale Display Function Standard.

Overview

- DICOM conformance
- Architecture of a typical medical visualization system
- Overview of Barco's DICOM THEATRE®
- Introduction to MGP configuration

6.1 DICOM conformance

Need for standardization

A digital signal from an image can be reproduced objectively and accurately. However, the visual interpretation of that signal is dependent on the characteristics of the systems displaying that image i.e. images produced by the same signal may appear different depending on the display device. In medical imaging, it is important that there be a visual consistency in how a given image appears, whether viewed, for example, on the display monitor of a workstation, a projector or as a film on a light-box. In the absence of any standard which regulates how these images are to be visually presented on any device, a digital image which has good diagnostic value when viewed on one device could look very different and have greatly reduced diagnostic value when viewed on another device.

Accordingly, PS 3.14 was developed to provide mapping of digital image values into a given range of Luminance. The mapping or relationship between digital values and display Luminance produces better visual consistency in how that image appears on diverse display devices. The relationship that PS 3.14 defines between digital image values and displayed Luminance is based upon measurements and models of human perception over a wide range of Luminance and thus independently of the nature of the presentation device.

It is also not dependent upon user preferences but uses a **DICOM Presentation Lookup Table**.



A system is DICOM-compliant when it respects a predefined relationship (PS3.14) between digital input signal values and display Luminance.

6.2 Architecture of a typical medical visualization system



LUT

Look Up Table. A table containing the displays output values (Luminance) in function of the input signal (amplitude)

System components

Basically a medical visualization system may contain:

- Calibration/Control unit
- Feedback unit
- Display unit

System Principal

A closed loop system insures a stable control system by means of a feedback signal being the Luminance at display level, and gets rid of possible drift (caused mainly by aging and external conditions) in the displayed Luminance value.

A control and calibration unit controls the display unit and insures the consistency of the displayed image according to a preset value of the **Display Function** and **Color temperature** defined by the user.

Both parameters define a particular LUT.

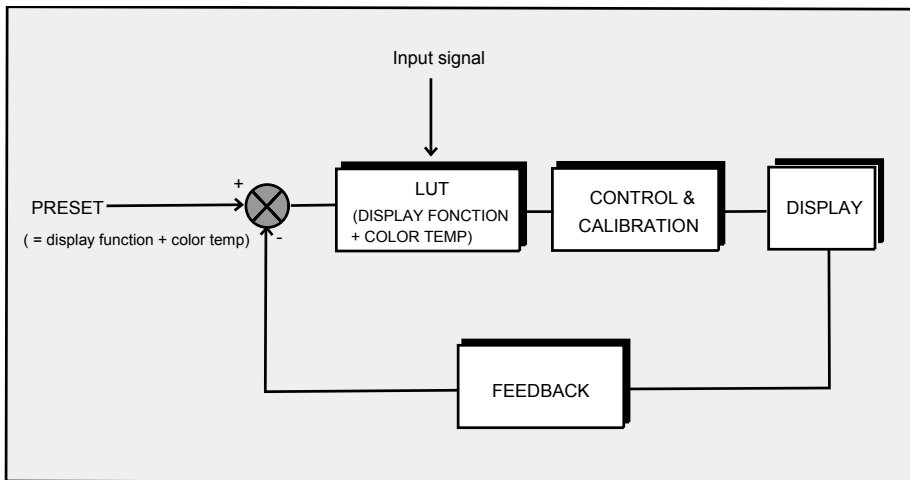

Image 6-1

6.3 Overview of Barco's DICOM THEATRE®

Architecture

A typical example of a medical visualization system is BARCO's DICOM compliant DICOM THEATRE®.

This system provides consistent images for consulting, reviewing and training applications.

In this system the MGP projector is used as the large screen display device controlled and tuned by the MediCal® Pro management software providing optimal image quality and consistency at any time.

Analogy to the typical architecture

- Display function : the function can be chosen to be DICOM, DIN, standard or custom. This is done in the projector.
- Preset: is determined by the user on MediCal® Pro and corresponds to a particular display function and color temperature.
- Control and calibration unit: Role played by MediCal® Pro .
- Display units: one or more flat panel displays and one or more projectors

6.4 Introduction to MGP configuration

Overview

- MGP main grayscale configuration tools

6.4.1 MGP main grayscale configuration tools

Available Presets

Basically the grayscale settings of the projector will depend on two factors

- Display function, page 69
- Color temperature, page 67

6 predetermined presets, containing each of them one particular display function and one particular color temperature, are stored in the projector, they can however be overwritten at any time by MediCal® Pro. The presets have been pre-calibrated by Barco and do not take account of any amount of ambient light, and could hence be referred to as DICOM compliant in dark room conditions at time of manufacturing. It is advised to re-calibrate these presets to match them to the actual environment.

The factory settings can be restored via the projector's menu.

Each time a preset is adapted, a calibration has to be done in order to verify conformance and consistency.

Preset	Display function	Color temperature	Application
Preset 1	DICOM	Clearbase	DICOM Theatre®
Preset 2	DICOM	Bluebase	
Preset 3	DICOM	Full white	
Preset 4	DIN	Clearbase	
Preset 5	DIN	Bluebase	
Preset 6	DIN	Full white	
-	DICOM	Custom	Standard Projection
-	DIN	Custom	
-	Standard	Full white	
-	Standard	Video (6500K)	
-	Standard	Computer (9300K)	

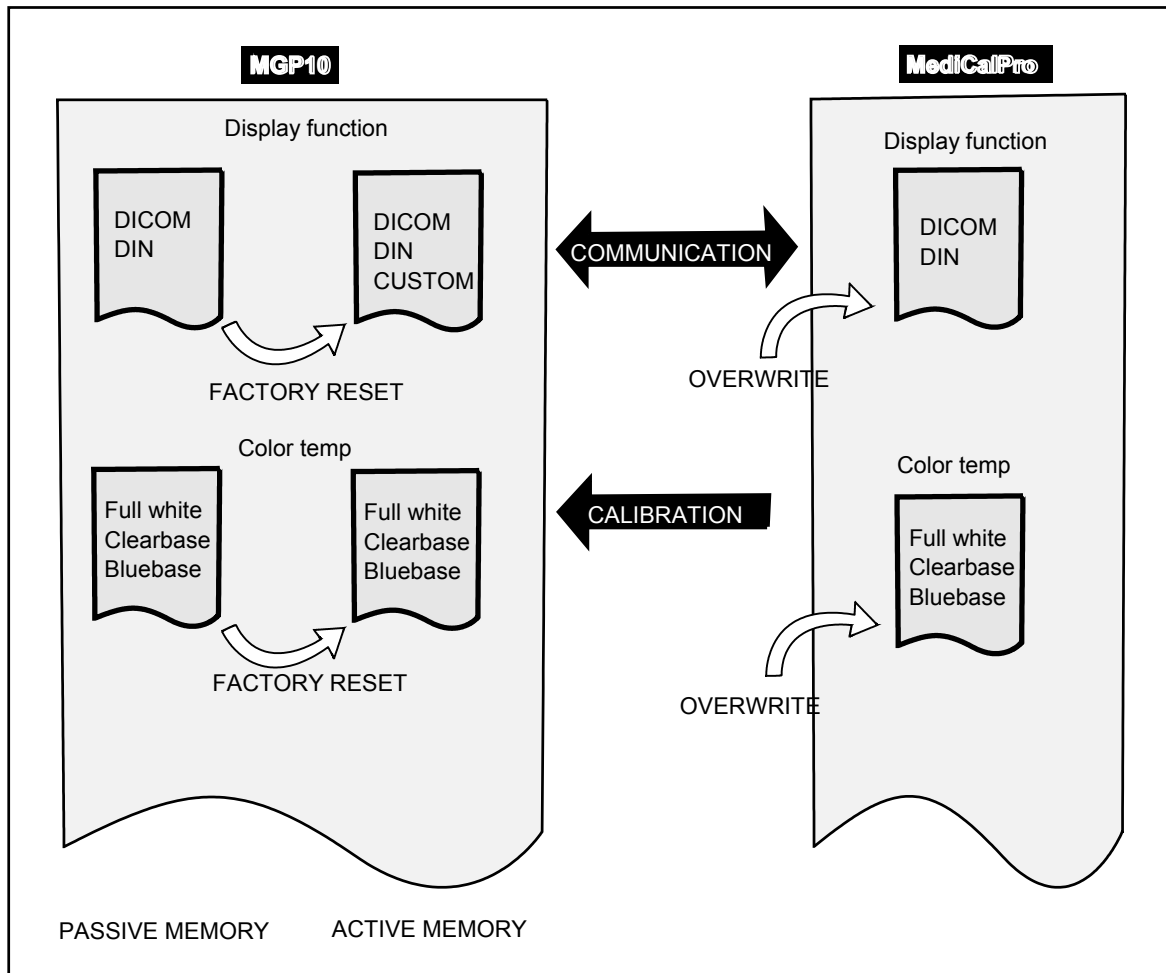

Image 6-2



It is recommended to use the DICOM presets since they give the best grayscale for medical applications.

7. MAIN MENU

7.1 Autoseg

Introduction to Autoseg

Autoseg creates the best suited image file for the connected source.

Therefore Autoseg calculates/measures several parameters of the sources:

- Total pixels per line
- Start pixel
- Phase
- Contrast/Brightness levels

The measure of the total number of pixels per line can be done through 2 methods

- Limited scan: a windowing is used to allow fast tracking, takes about ...
- Full scan: tracking is done over the full range, takes about ...

How to setup the scan method ?

1. Press **MENU** to activate the Toolbar
2. Press → to select the *Main* item
3. Press ↓ to Pull down the *Main* menu
4. Use ↑ or ↓ to select *Autoseg*
5. Press → to pull down the menu (image 7-1)
6. Use ↓ or ↑ to select the desired method
7. Press **ENTER**



Image 7-1

8. ADJUSTMENTS

Overview

- Contrast
- Brightness
- Phase
- Gamma
- Custom color temperature adjustment
- Scaling
- Aspect ratio
- Positioning
- Image settings
- RGB Low Pass filter
- Standby Timer
- Blanking
- Autosetup parameters

8.1 Contrast

How to change the contrast ?

1. Press **MENU** to activate the Toolbar
2. Press → to select the *Adjustments* item
3. Press ↓ to Pull down the menu
4. Use ↑ or ↓ to select *Contrast* (image 8-1)
5. Press **ENTER**

A sliderbox is displayed

6. Use ←or →, the numeric keys on the remote, or the keypad to change the Contrast. (image 8-2)

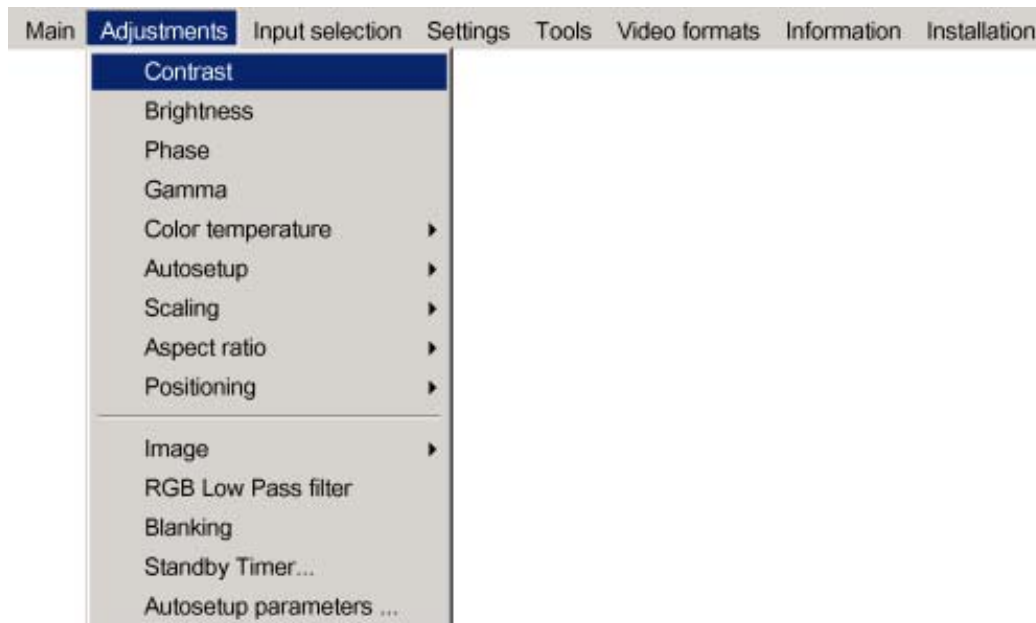

Image 8-1

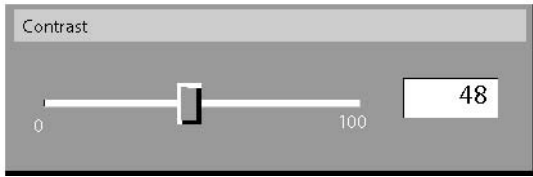

Image 8-2



Contrast adjustment is only possible if the *Display function* is *Standard*.
In the other modes (*DICOM, DIN, CUSTOM*) the contrast adjustment is disabled.

8.2 Brightness

How to change the brightness ?

1. Press **MENU** to activate the Toolbar
2. Press → to select the *Adjustments* item
3. Press ↓ to Pull down the menu
4. Use ↑ or ↓ to select *Brightness* (image 8-3)
5. Press **ENTER**
A sliderbox is displayed
6. Use ←or →, the numeric keys on the remote, or the keypad to change the Brightness.

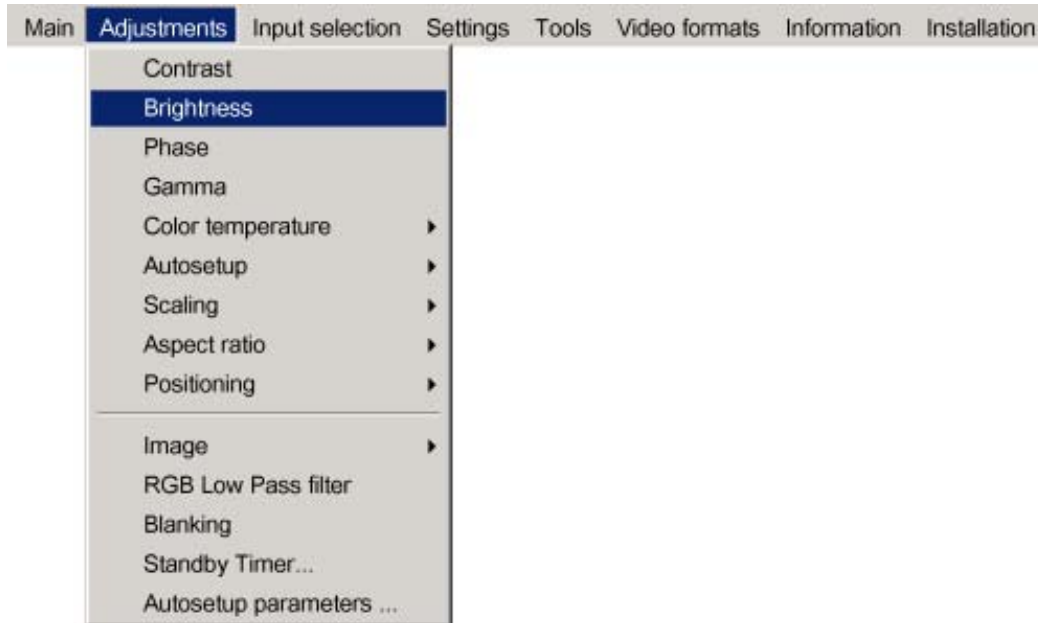

Image 8-3



Brightness adjustment is only possible if the *Display function* is *Standard*.
In the other modes (*DICOM, DIN, CUSTOM*) the brightness adjustment is disabled.

8.3 Phase

How to change the Phase ?

1. Press **MENU** to activate the Toolbar
2. Press → to select the *Adjustments* item
3. Press ↓ to Pull down the menu
4. Use ↑ or ↓ to select *Phase*
5. Press **ENTER**
A sliderbox is displayed
6. Use ←or →, the numeric keys on the remote, or the keypad to change the Phase.

8.4 Gamma



Gamma

Signal-Light transfer characteristic of a display.

Gamma adjustment

In the MGP10 the Gamma adjustment remains only adjustable in the *Standard* Display Function i.e. only if used for projection without any constraint with respect to consistency and conformance. The adjustment allows an adjustment in a range from 1.6 to 2.8.

A gamma of 2.2 is considered as the typical value for video signals.

When a Display Function is chosen to be *DICOM*, *DIN* or *Custom* then the Gamma function or more generally the signal to luminance characteristic is at the same time determined.

How to change the Gamma ?

1. Press **MENU** to activate the Toolbar
2. Press → to select the *Adjustments* item
3. Press ↓ to Pull down the menu
4. Use ↑ or ↓ to select *Gamma*
5. Press **ENTER**
A sliderbox is displayed.
6. Use ←or →, the numeric keys on the remote, or the keypad to change the Gamma.



Gamma adjustment is only possible if the *Display function* is *Standard*.

In the other modes (*DICOM*, *DIN*, *Custom*) the Gamma adjustment is disabled since the signal-light function is determined by the Display Function (*DICOM*, *DIN*, *Custom*)

8.5 Custom color temperature adjustment

How to edit the custom color temperature ?

1. Press **MENU** to activate the Toolbar
2. Press → to select the *Adjustments* item
3. Press ↓ to Pull down the menu
4. Use ↑ or ↓ to select *Color temperature*
5. Press → to open the *Color temperature* item and select *Edit RGB* (image 8-4)
6. Press **ENTER**
A sliderbox for the Red custom setting is displayed as well as a wizard textbox in the lower part of the screen. (image 8-5, image 8-6)
7. Use ←or →, the numeric keys on the remote, or the keypad to change the Color temperature.
8. Follow the instructions on the wizard textbox.

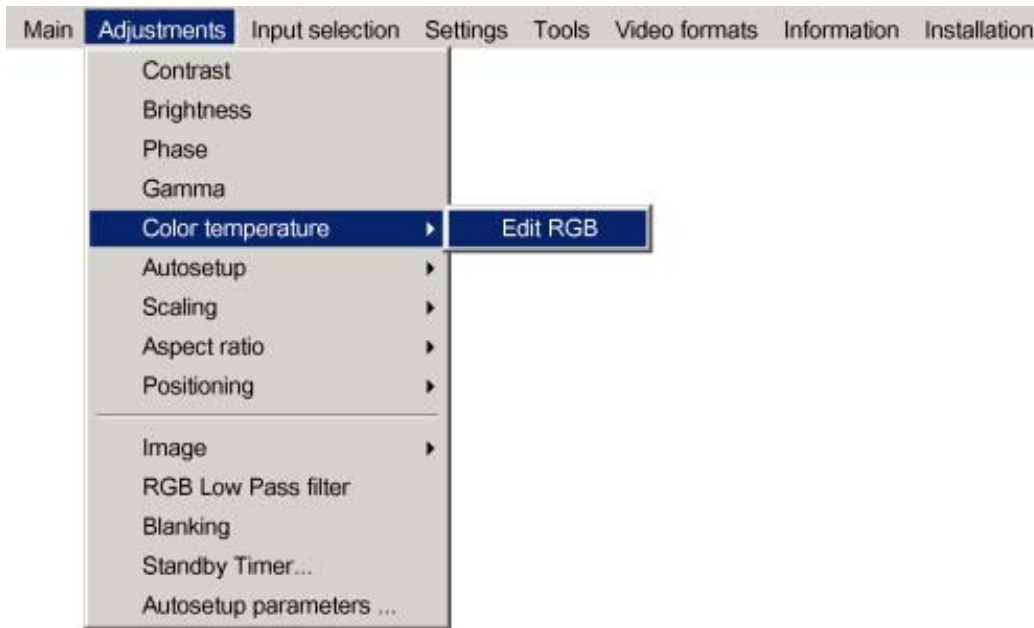

Image 8-4



Image 8-5



Image 8-6



The custom color temperature can only be selected in the *Standard* projection mode (Display function = standard).

8.6 Scaling

What are the different scaling methods ?

- *Best Fit*: forces to use the maximum resolution of the LCD panels by preserving the selected aspect ratio, "Aspect ratio", page 51
- *None*: uses the native resolution of the source, the aim being here to always show the resolution of the source, independently of the resolution of the LCD panels.
The "show native resolution" function will handle the sources as shown in the table.
- *Full screen*: The *Full screen* method forces to use the complete native resolution of the LCD panels independently of the native resolution of the source.

Source			Projected image		
Name	Ratio	Resolution	Ratio	Resolution	Particularities Reality
xga	4:3	1024x768	4:3	1024x768	image centered +side blanked
sxga	5:4	1280x1024	5:4	1280x1024	image centered +side blanked
sxga+	4:3	1400x1050	4:3	1400x1050	part of the image not displayed
uxga	4:3	1600x1200	4:3	1600x1200	part of the image not displayed

Table 8-1
Scaling method = None in case of a MGP10 projector



The *None* and the *Full screen* setting overrule the *Aspect Ratio* setting.

How to set the scaling method ?

1. Press **MENU** to activate the Toolbar
2. Press **→** to select the *Adjustments* item
3. Press **↓** to Pull down the menu
4. Use **↑** or **↓** to select the *Scaling* (image 8-7)
5. Press **→** to pull down the menu
6. Use **↑** or **↓** to select the desired method
7. Press **ENTER**

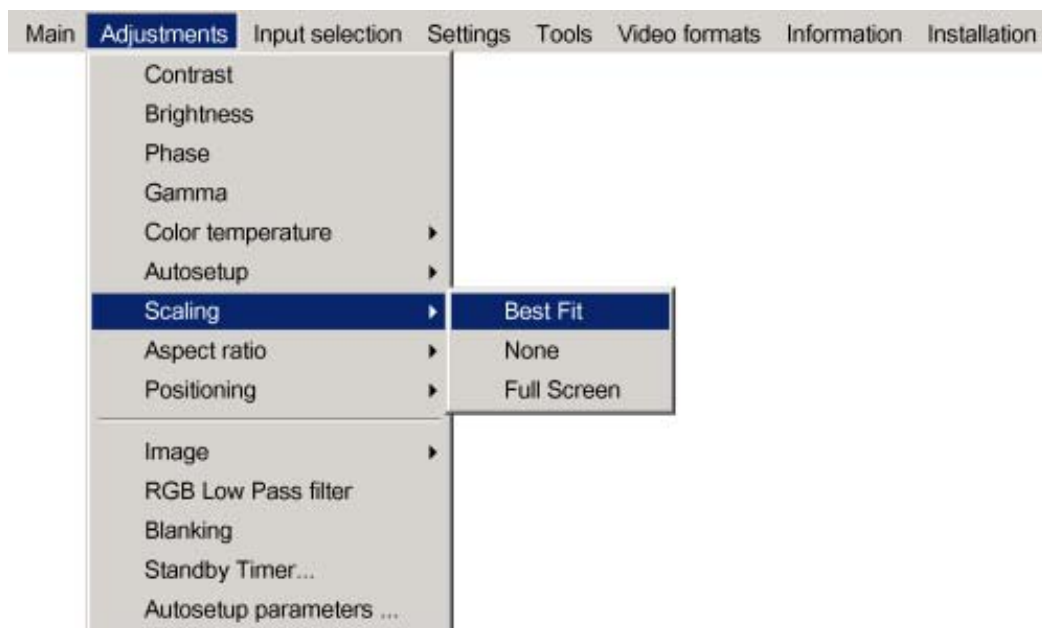

Image 8-7

8.7 Aspect ratio

What can be done ?

The aspect ratio setting forces the projector to project an image using a defined aspect ratio.

8. Adjustments

- 4:3
- 16:9
- 5:4
- Auto

The Auto function calculates an aspect ratio based on the information stored in the image files.



Selecting Auto in case of a Video source may shrink the image horizontally

How to change the Aspect ratio ?

1. Press **MENU** to activate the Toolbar
2. Press → to select *Adjustment*
3. Press ↓ to Pull down the menu (image 8-8)
4. Use ↑ or ↓ to select *Aspect ratio*
5. Press **ENTER** to confirm

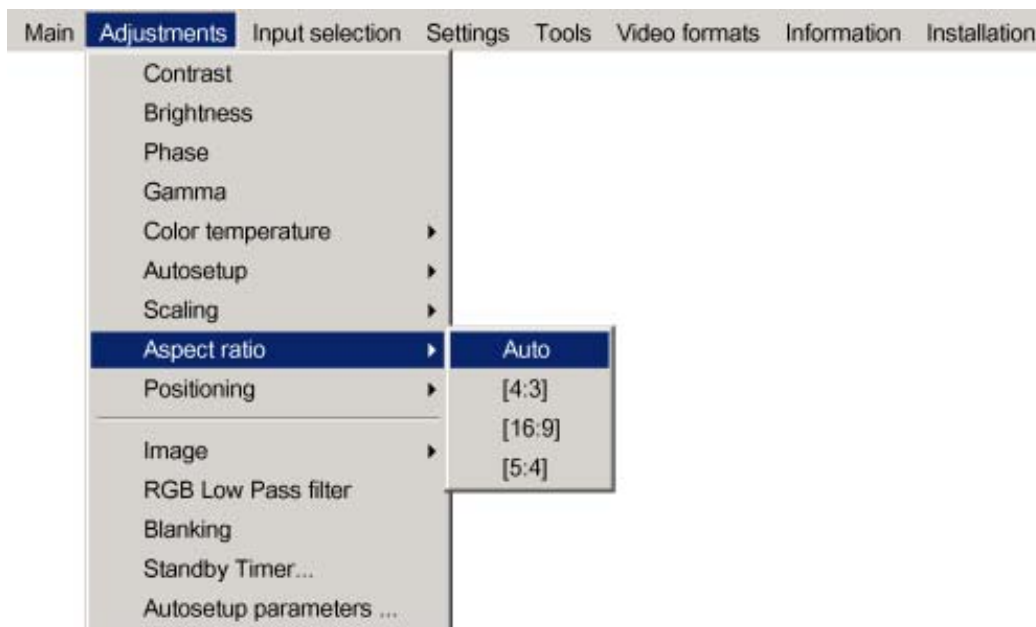

Image 8-8



The Aspect ratio menu is greyed out in case of a *None* or *Full screen* scaling, see "Scaling", page 50

8.8 Positioning

What can be done ?

The pixel start and line start calculated by *Autosetup* (values can be read in the image file) can be adapted.

This adaptation can be seen as a horizontal (pixel start) and vertical image shift (line start).

How to reposition the image ?

1. Press **MENU** to activate the Toolbar
2. Press → to select the *Adjustments* item
3. Press ↓ to Pull down the menu
4. Use ↑ or ↓ to select *Positioning*

5. Press → to pull down the menu
6. Use ↑ or ↓ to select *Horizontal* or *Vertical* (image 8-9)
7. Press **ENTER**
A sliderbox is displayed.
8. Use ←or →, the numeric keys on the remote, or the keypad to change the filter level.

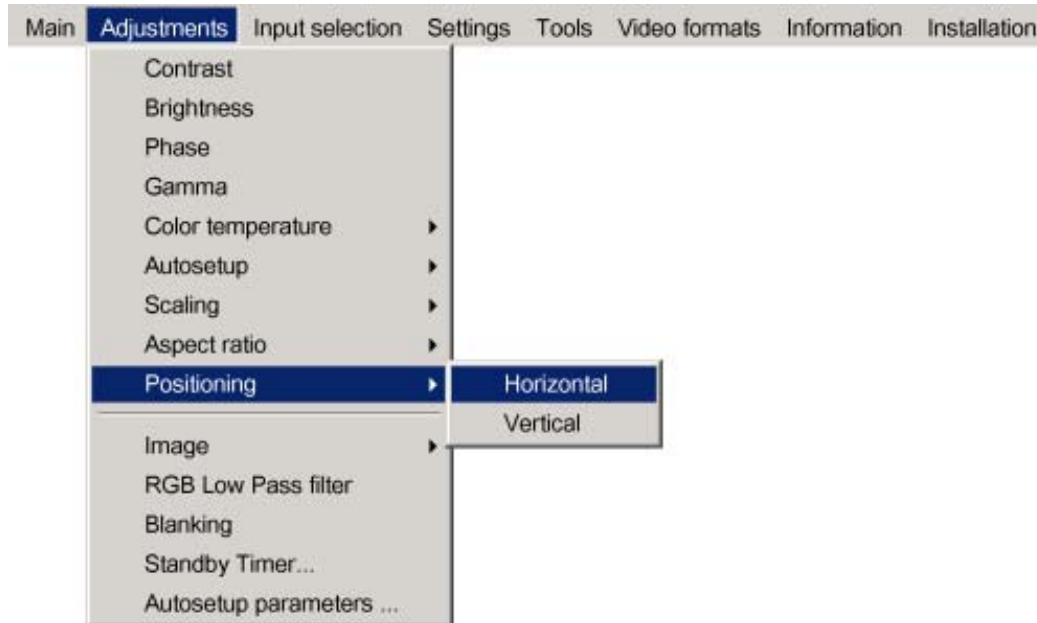

Image 8-9

8.9 Image settings

How to adjust colour ?

1. Press **MENU** to activate the Toolbar
2. Press → to select the *Adjustments* item
3. Press ↓ to Pull down the menu
4. Use ↑ or ↓ to select *Image*
5. Press → to pull down the menu
6. Use ↑ or ↓ to select *colour* (image 8-10)
7. Press **ENTER**
A sliderbox is displayed
8. Use ←or →, the numeric keys on the remote, or the keypad to change the colour.

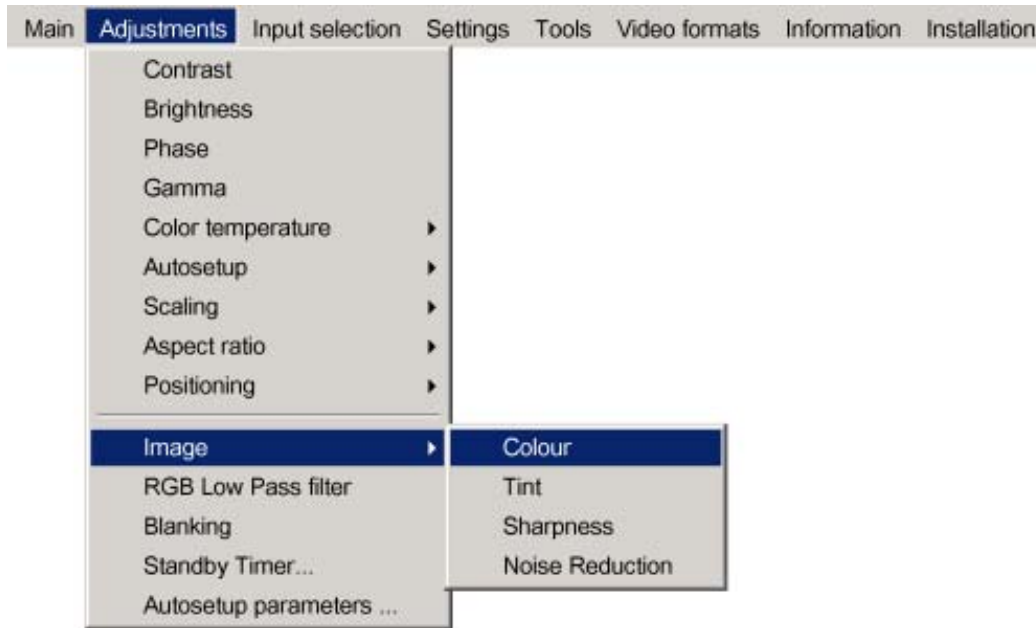

Image 8-10

How to adjust Tint ?

1. Press **MENU** to activate the Toolbar
2. Press → to select the *Adjustments* item
3. Press ↓ to Pull down the menu
4. Use ↑ or ↓ to select *Image*
5. Press → to pull down the menu
6. Use ↑ or ↓ to select *Tint* (image 8-11)
7. Press **ENTER**
A sliderbox is displayed
8. Use ← or →, the numeric keys on the remote, or the keypad to change the Tint.

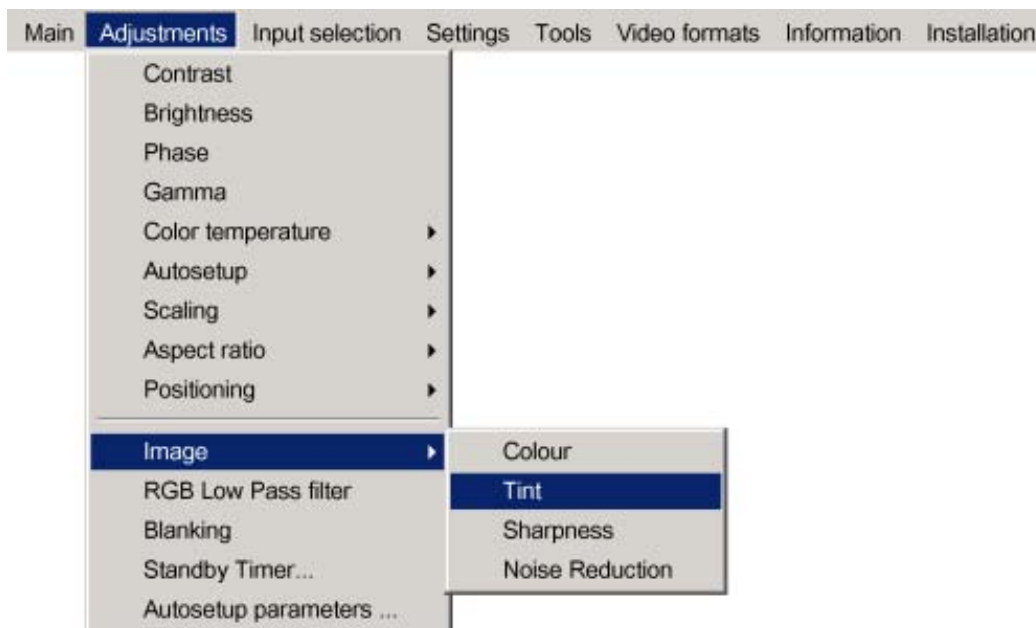

Image 8-11

How to adjust Sharpness ?

1. Press **MENU** to activate the Toolbar
2. Press → to select the *Adjustments* item
3. Press ↓ to Pull down the menu
4. Use ↑ or ↓ to select *Image*
5. Press → to pull down the menu
6. Use ↑ or ↓ to select *Sharpness* (image 8-12)
7. Press **ENTER**
 - A sliderbox is displayed
8. Use ←or →, the numeric keys on the remote, or the keypad to change the Sharpness.

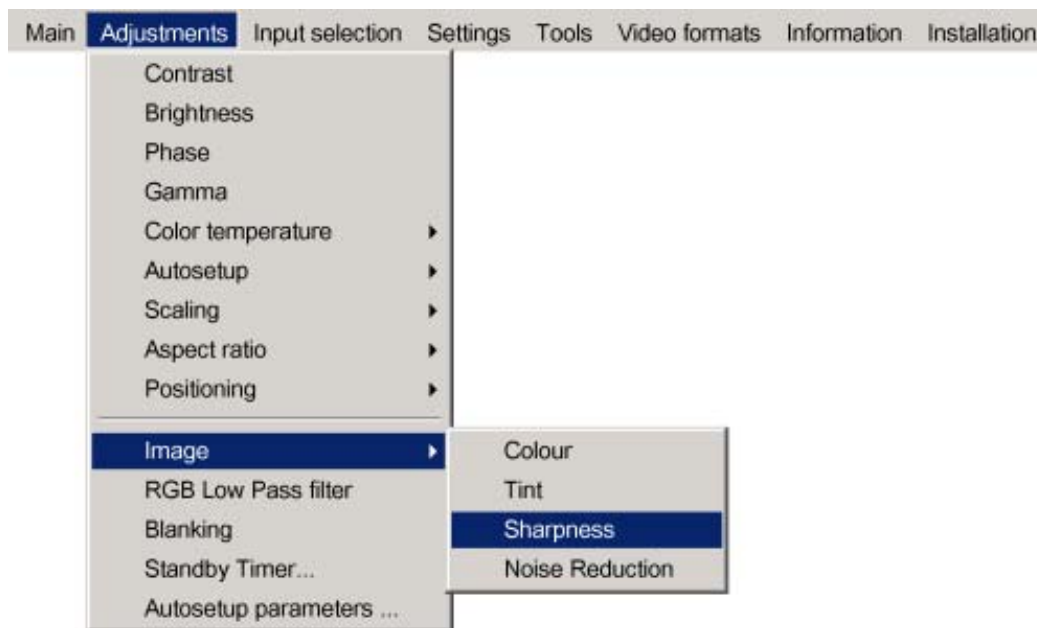

Image 8-12

How to adjust the Noise Reduction ?

1. Press **MENU** to activate the Toolbar
2. Press → to select the *Adjustments* item
3. Press ↓ to Pull down the menu
4. Use ↑ or ↓ to select *Image*
5. Press → to pull down the menu
6. Use ↑ or ↓ to select *Noise Reduction* (image 8-13)
7. Press **ENTER**
 - A sliderbox is displayed
8. Use ←or →, the numeric keys on the remote, or the keypad to change the Noise Reduction.

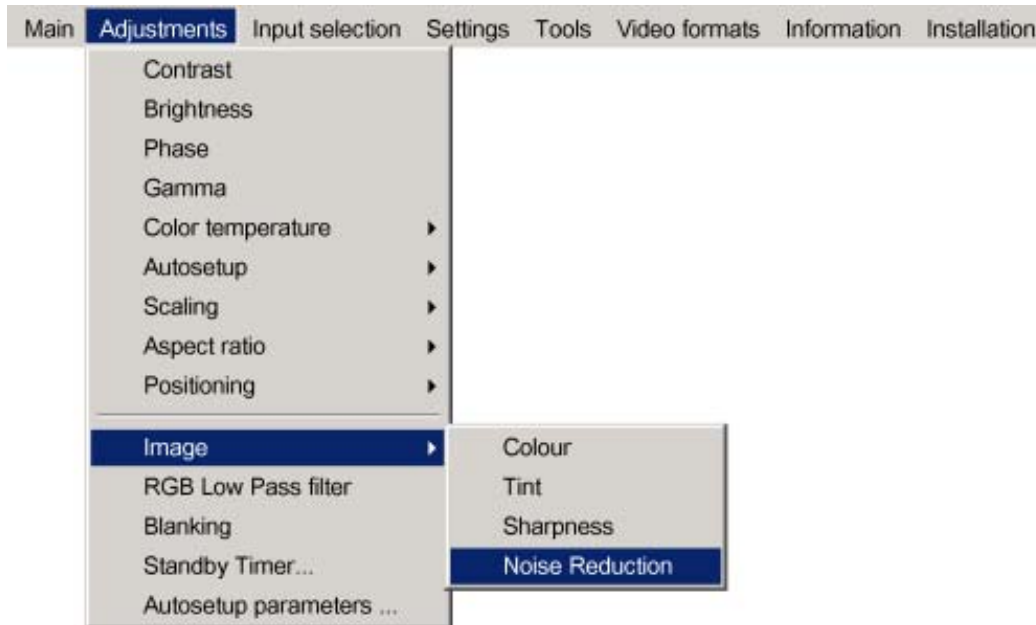

Image 8-13

8.10 RGB Low Pass filter

Input filtering

The input section of the projector allows an additional filtering of the RGB signal by means of a 4 level (0–4) filter setup and can result in a more stable and crisp image, especially with respect to phase stability.



works only on the RGB input

How to set the RGB Low pass filter ?

1. Press **MENU** to activate the Toolbar
2. Press → to select the *Adjustments* item
3. Press ↓ to Pull down the menu
4. Use ↑ or ↓ to select *RGB Low pass filter* (image 8-14)
5. Press **ENTER**
A sliderbox is displayed
6. Use ← or →, the numeric keys on the remote, or the keypad to change the filter level.

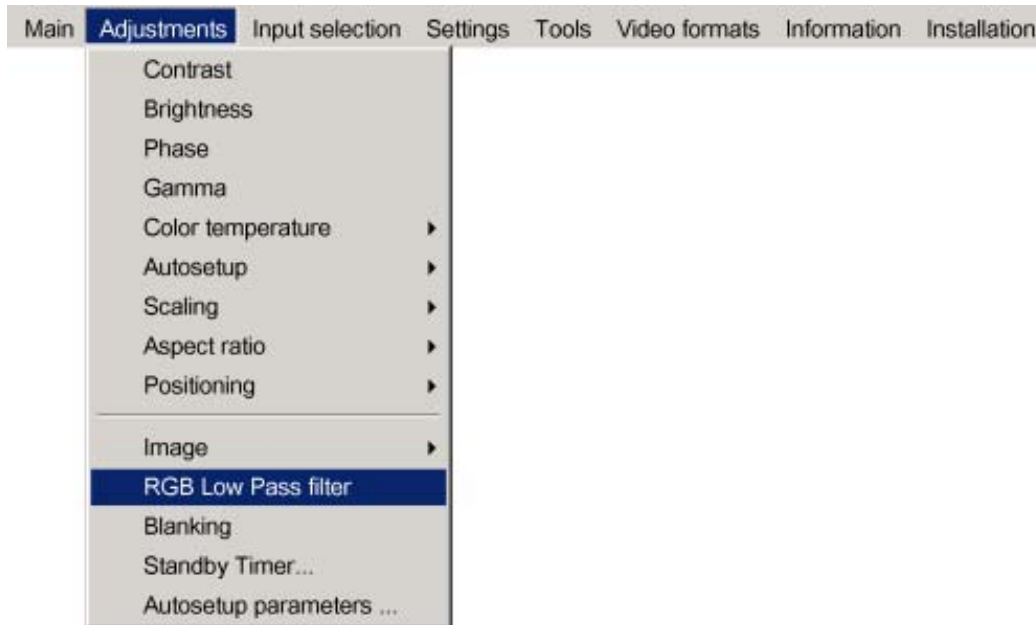

Image 8-14

8.11 Standby Timer

Purpose of the Standby Timer

If there is no signal, and the standby timer is enabled, a dialogbox is displayed and the projector will shut down after a determined time.



Image 8-15

The countdown time can be set in a dialog box in a range from 180 to 3600 seconds (default value = 300). The Timer can also be disabled.

How to enable the timer ?

1. Press **MENU** to activate the Toolbar
2. Press → to select *Adjustment*
3. Press ↓ to Pull down the menu
4. Use ↑ or ↓ to select *Standby Timer* (image 8-16)
5. Press **ENTER** to activate the function
On the screen appears a dialogbox (image 8-17)
6. Use ↑ or ↓ to select *Enabled*, a box surrounds the selected item, press **ENTER** to activate
7. Use ↑ or ↓ to browse to the input field
8. Use ←or→ , the numeric keys on the remote or the keypad to change the countdown setting
9. Press **MENU** or **BACK** to exit or to go back to the previous menu

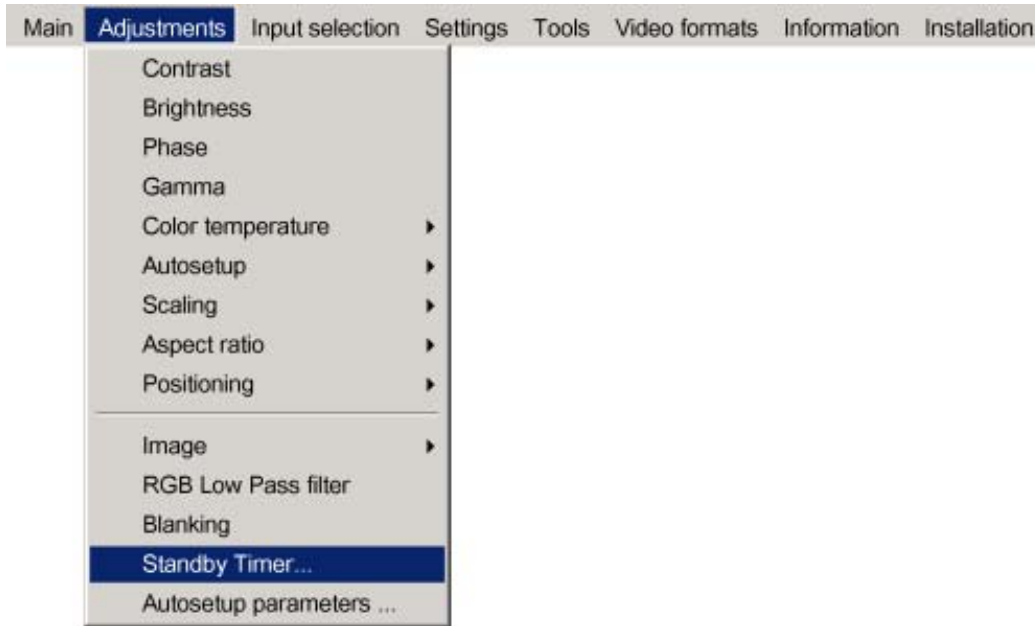

Image 8-16

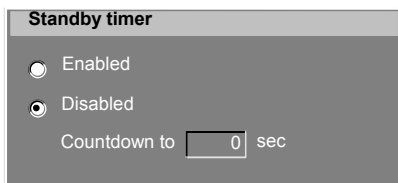

Image 8-17

8.12 Blanking

What can be done ?

The image can be blanked in several ways :

- Top blanking
- Bottom blanking
- Left blanking
- Right blanking

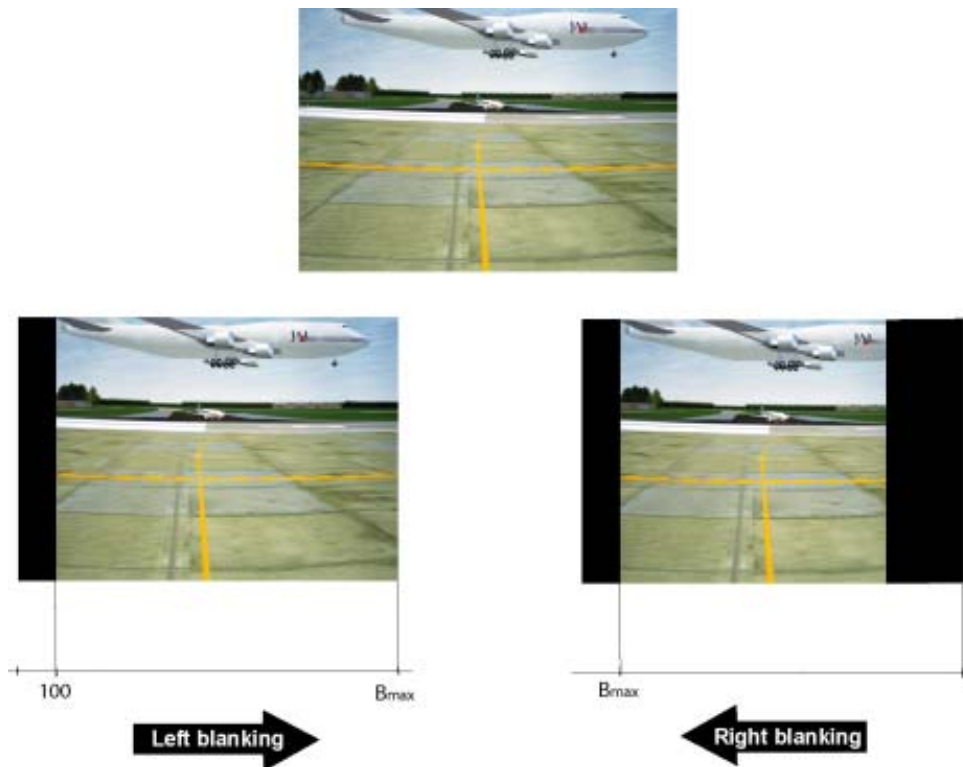

Image 8-18

How to blank the image ?

1. Press **MENU** to activate the Toolbar
2. Press **→** to select the *Adjustments* item
3. Press **↓** to Pull down the menu
4. Use **↑** or **↓** to select *Blanking* (image 8-19)
5. Press **ENTER**
 - A sliderbox is displayed (image 8-20)
6. Use **←** or **→**, the numeric keys on the remote, or the keypad to change the blanking.

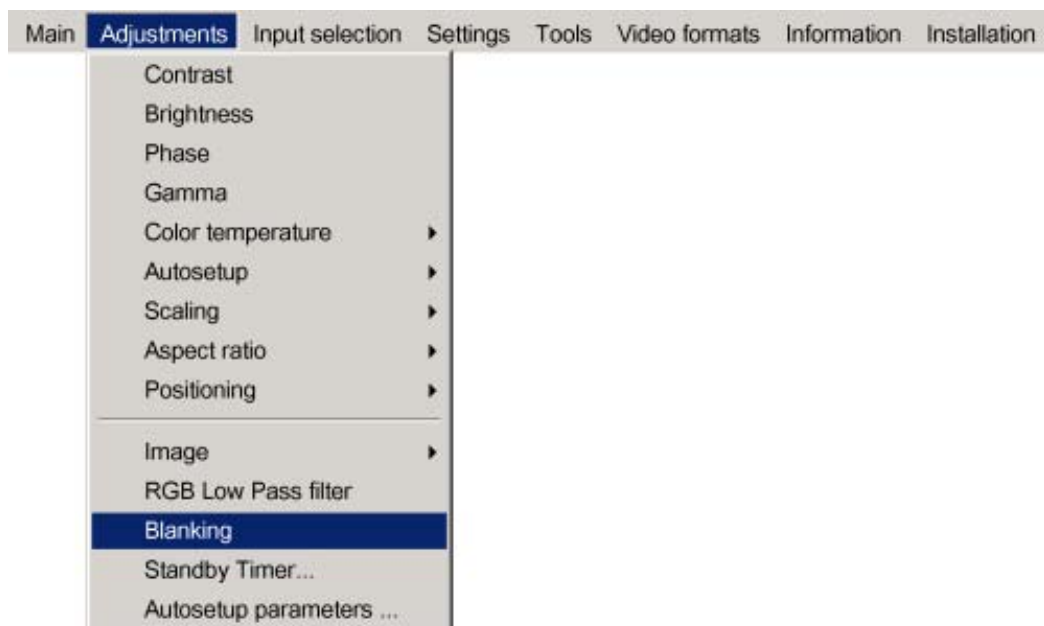

Image 8-19

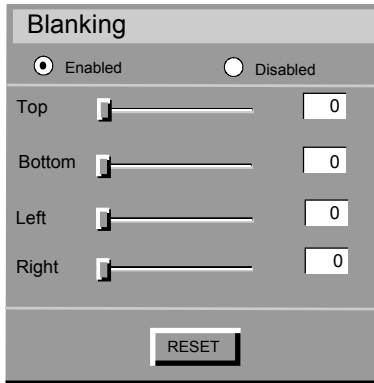

Image 8-20



Use the checkboxes to enable/disable the blanking
Use the Reset key to reset the blanking values.



The logo is also affected by the blanking

8.13 Autosegment parameters

What can be done ?

The autosegment can be done by using automatic adjustments of following parameters:

- Frequency : adjust automatically the total number of pixels of the detected source
- Phase : adjusts automatically the phase of the detected source
- Geometry : adjusts automatically the total number of lines of the selected source
- Gain : adjusts automatically the contrast/brightness settings of the selected source

All these parameters can be chosen to be taken in account or not during the Autosegment process, enabling or disabling the options is done by checking or unchecking the corresponding case.

How to setup ?

1. Press **MENU** to activate the Toolbar
2. Press **→** to select *Adjustment*
3. Press **↓** to Pull down the menu
4. Use **↑** or **↓** to select *Autosegment parameters* (image 8-21)
5. Press **ENTER** to activate the function
On the screen appears a dialogbox (image 8-22)
6. Use **↑** or **↓** to select the desired parameter, a box surrounds the selected item, press **ENTER** to activate
7. Press **MENU** or **BACK** to exit or to go back to the previous menu

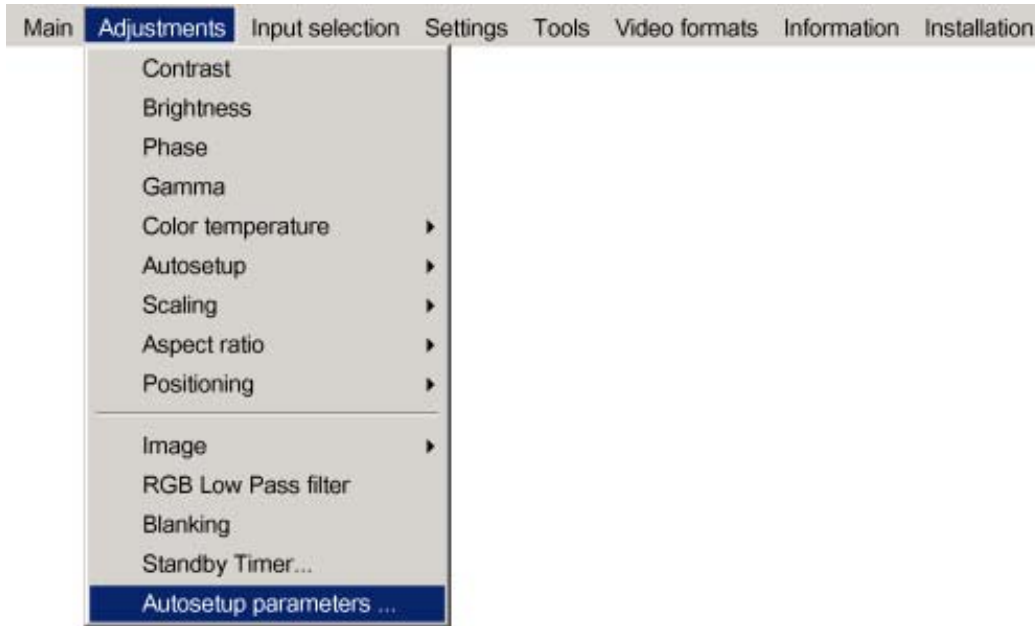

Image 8-21

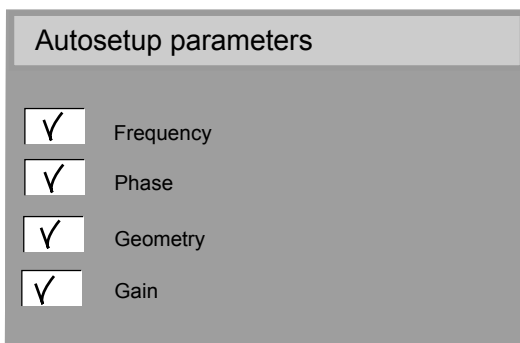

Image 8-22

9. INPUT SELECTION

Overview

- Input selection
- Displaying the Logo
- Pause
- Freeze

9.1 Input selection

Selection method

The MGP10 offers a user-friendly way to select the desired input to be projected. 5 different selectable inputs are available in the input selection menu, each of them is indicated with 2 icon :

- a slot number icon : icon representing the shortcut numeric key to be entered on the RCU to select the same input
- a Barco icon : indicates the presence of that particular source.



Another way of selecting an input is via the RCU using the numeric keys or via the local keypad.

BNC configuration

The advanced part of the source selection menu allows to configure the 5 BNC's. In other words, one must specify which signal is present on the 5 BNC's in order to allow the appropriate processing.

- Data on BNC's : must be selected when a data signal is present on the BNC's.
An example is a RGBHV signal coming from a computer.
- Component video : must be selected when a signal of the type PR/Y/PB is connected to the BNC's.
An example is a component signal coming from a professional DVD player
- RG_(s)B Video : must be selected when an RGB video signal with Sync on Green or sync on H is presented on the BNC's.



In case of an RG(s)B configuration of the BNC's, the signal is routed to the video circuit and is projected in a video window (see PiP).

How to select an input ?

1. Press **MENU** to activate the Toolbar
2. Press → to select the *Input Selection* item
3. Press ↓ to Pull down the menu
4. Use ↑ or ↓ to select the input (image 9-1)
5. Press **ENTER**

The selected input is displayed

9. Input Selection

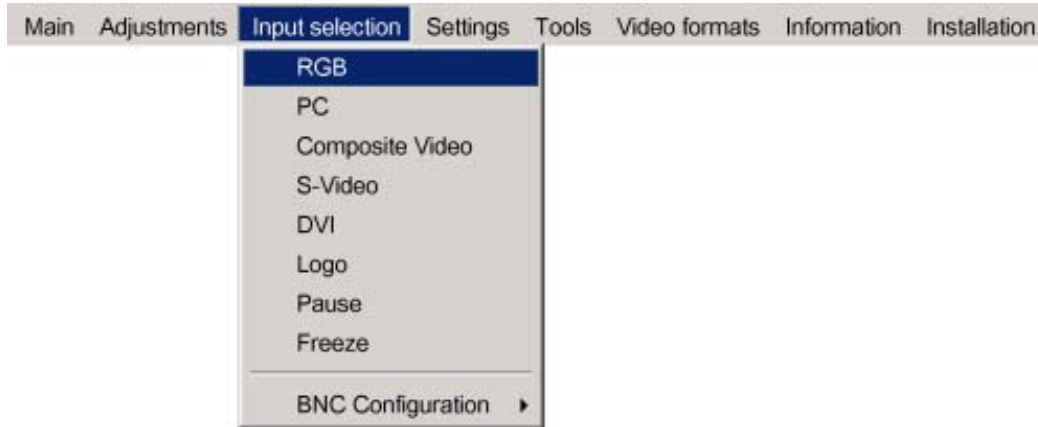

Image 9-1

How to configure the 5 BNC's ?

1. Press **MENU** to activate the Toolbar
2. Press → to select the *Input Selection* item
3. Press ↓ to Pull down the menu
4. Use ↑ or ↓ to select *BNC configuration*
5. Press → to open the menu
6. Use ↑ or ↓ to select the desired configuration (image 9-2)
7. Press **ENTER**

The selected configuration is indicated with a bullet

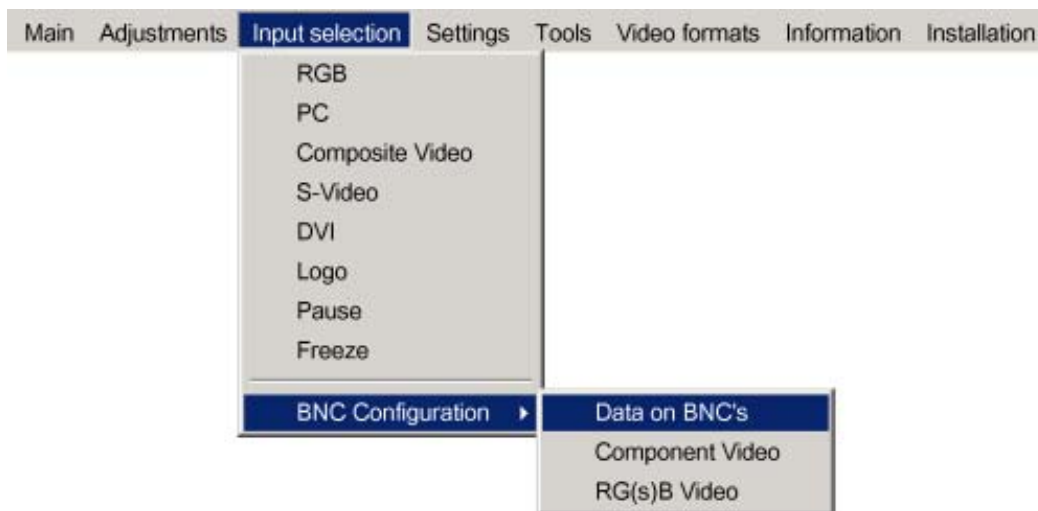

Image 9-2

9.2 Displaying the Logo

Logo

The projector is factory fitted with a standard Barco Logo (SXGA resolution), however it can be replaced by a new corporate logo using the *Take screenshot* function.

Logo display is done automatically in case of signal absence under the condition that *Background* is set to Logo



A standby timer can also be set to put the projector in standby after a predetermined time in case of signal absence.

How to display the logo ?

1. Press **MENU** to activate the Toolbar
2. Press → to select the *Input Selection* item
3. Press ↓ to Pull down the menu
4. Use ↑ or ↓ to select *Logo* (image 9-3)
5. Press **ENTER**

The logo is displayed

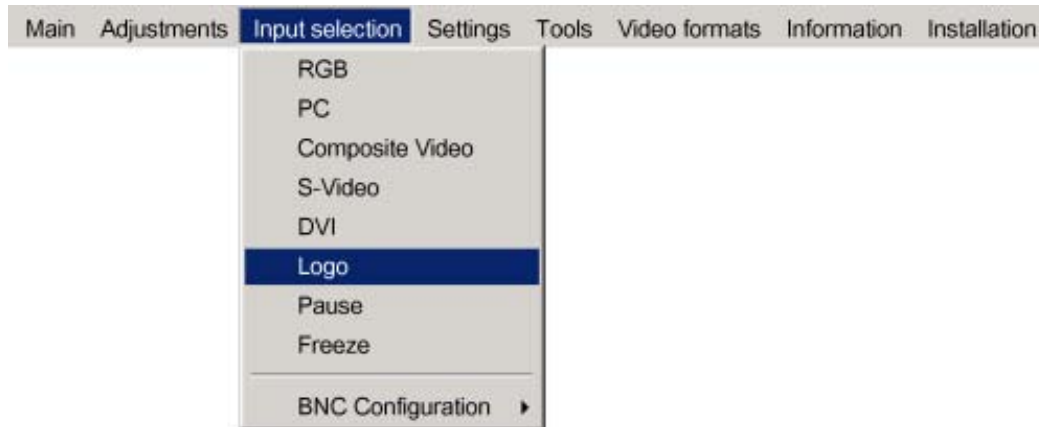

Image 9-3

9.3 Pause

Interrupting the image projection

With the Pause function, the image projection can be stopped, the projector remains with full power for immediate restart. The projection is interrupted by means of a mechanical shutter cutting the light beam.

How to interrupt the image projection ?

1. Press **MENU** to activate the Toolbar
2. Press → to select *Input Selection*
3. Press ↓ to Pull down the menu
4. Use ↑ or ↓ to select *Pause* (image 9-4)
5. Press **ENTER** to activate the Pause function

A brief sound indicates that the shutter has been activated.

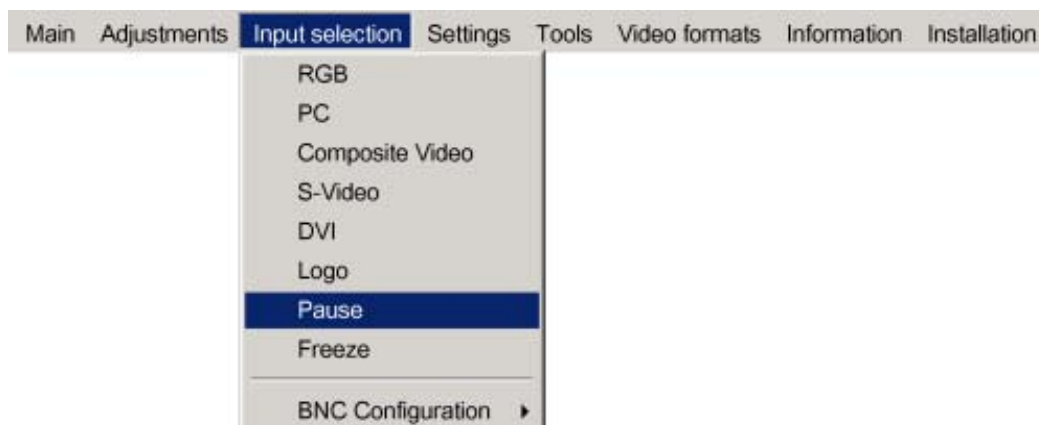

Image 9-4



The image projection can also be interrupted using the PAUSE key on the RCU.
To restart the image : press PAUSE, MENU, BACK or LOGO

9.4 Freeze

Freezing the image

With the Freeze function, the image can be frozen. To restart the image, reuse the Freeze function or press the **FREEZE** button on the remote.

How to freeze the image ?

1. Press **MENU** to activate the Toolbar
2. Press → to select *Input Selection*
3. Press ↓ to Pull down the menu
4. Use ↑ or ↓ to select *Freeze* (image 9-5)
5. Press **ENTER** to activate the Freeze function

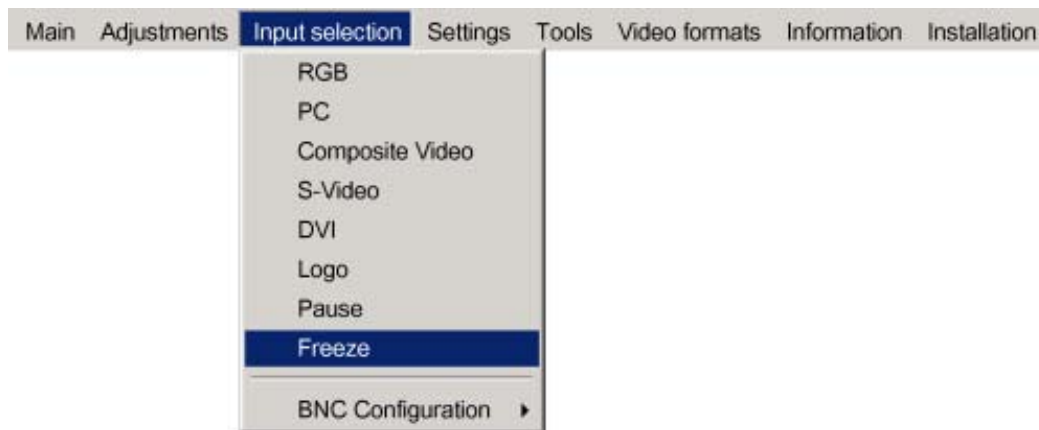

Image 9-5



The image can also be frozen using the FREEZE key on the RCU

10. SETTINGS

Overview

- Color temperature
- Display function
- Restoring the factory settings
- Black and white selection
- User Control
- Lamp mode selection
- Runtime warning
- Input Balance
- AGC on Video
- Manual Gain Control
- Lamps

10.1 Color temperature

10.1.1 Color temperatures in greyscale mode reproduction

Color temperatures in greyscale mode reproduction

Beside the standard projection color temperature Video (6500K), computer (9300K) and full white, 2 additional medical related color temperatures are added:

- Clearbase
CIE graph coordinates: $x = 0.28$; $y = 0.304$
- Bluebase
CIE graph coordinates: $x = 0.25$; $y = 0.305$

Since the projector is operating most of the time in greyscale mode meaning a B/W signal is to be reproduced, the color temperature setting can be seen as an adjustment of the neutral greyscale color temperature.

These 2 predefined color temperatures (as well as Full White) are used to form, in combination with a display function, a **preset** for greyscale reproduction.

That way, 6 presets are defined and can be selected by the user through the projector menu or remotely by the MediCal® Pro (in case of a Barco DICOM Theatre system)

10.1.2 Color temperature in a standalone projector setup

Color temperature setting

In a standalone or open loop system i.e. without any feedback from the screen, the color temperature is defined by the user via the OSD of the projector. The selected color temperature is then the value as it was set in the factory.



Factory settings are “dark room” settings meaning they do not take account of environmental conditions (ambient light, glare,...).

How to define a color temperature via the projector menu (standalone setup) ?

1. Press **MENU** to activate the Toolbar
2. Press → to select the *Settings* item
3. Press ↓ to Pull down the *Settings* menu
4. Use ↑ or ↓ to select *Color temperature*
5. Press → to pull down the menu
6. Use ↓ or ↑ to select the desired color temperature (image 10-1)
7. Press **ENTER**

The color temperature is adapted.

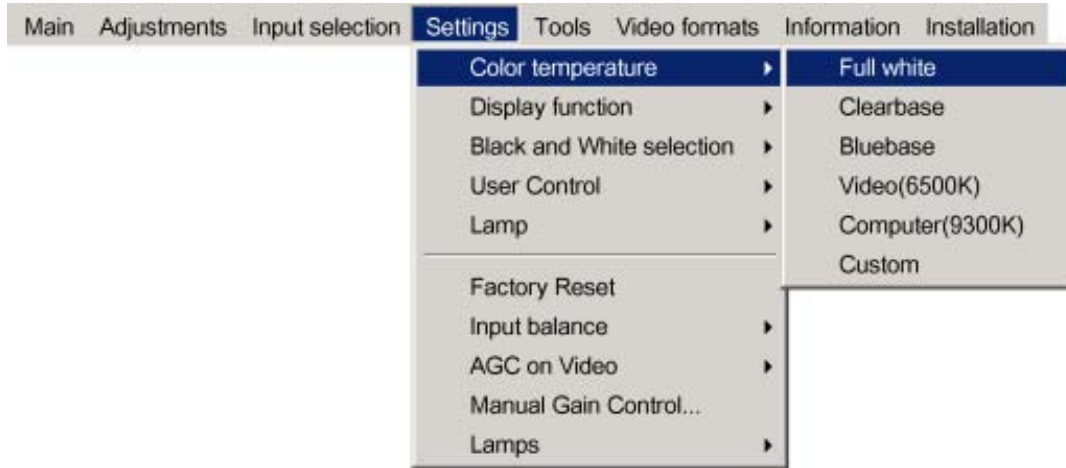

Image 10-1



The custom color temperature allows the selection of a user defined color temperature set in the *Adjustment* menu.

10.1.3 Color temperature in a closed loop medical visualization system

Color temperature in a closed loop medical visualization system

If, however the projector is part of a typical closed loop medical visualization system (Barco Dicom® Theatre), color temperature will be set by the control & calibration system (MediCal® Pro) along with a display function forming a pre-set value.

The preset (formed by color temperature and display function) values are checked on a regular basis to verify if the projected image is within a tolerance with respect to consistency, in the case it isn't, a **calibration** process will be launched.

How to select a color temperature ?

1. Refer to the system manual

OSD interaction

When a preset is selected on MediCal® Pro , the selected color temperature (as well as the display function) will be marked on the projector's OSD menu.



Image 10-2

The completion of the calibration procedure will in the same way be signaled by a separate logo (as well as for the display function).

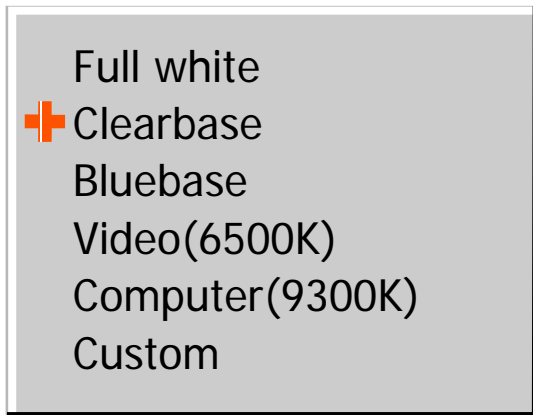

Image 10-3

10.2 Display function

Overview

- Display function in a standalone projector setup
- Display function in a closed loop medical visualization system

10.2.1 Display function in a standalone projector setup

Display function setting

In a standalone or open loop system i.e. without any feedback from the screen, the display function is defined by the user via the OSD of the projector. The selected display function corresponds then to a Look Up Table (LUT) as it is was set in the factory.



Factory settings are “dark room” settings meaning they do not take account of environmental conditions (ambient light, glare,...).

How to define a display function via the projector menu (standalone setup) ?

1. Press **MENU** to activate the Toolbar
2. Press → to select the *Settings* item
3. Press ↓ to Pull down the *Settings* menu
4. Use ↑ or ↓ to select *Display function*
5. Press → to pull down the menu
6. Use ↓ or ↑ to select the desired display function (image 10-4)
7. Press **ENTER**

The display function is adapted and the corresponding LUT is loaded.

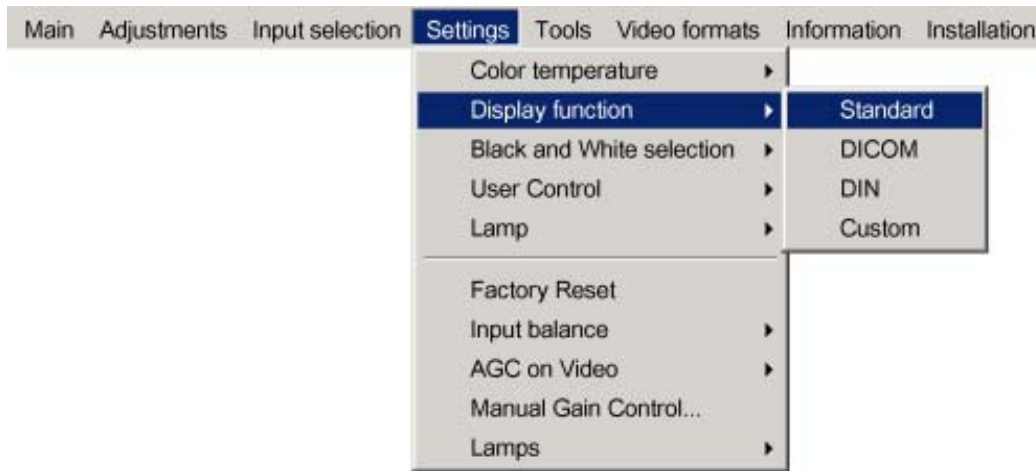

Image 10-4



The custom display function allows the selection of a user defined display function set in Factory, which is a linear function (Gamma = 1)

10.2.2 Display function in a closed loop medical visualization system

Display function in a closed loop medical visualization system

If, however the projector is part of a typical closed loop medical visualization system (Barco Dicom® Theatre), the Display function will be set by the control & calibration system (MediCal® Pro) along with a color temperature forming a pre-set value.

How to select a Display function ?

1. Refer to the system manual

OSD interaction

When a preset is selected on MediCal® Pro , the selected Display function (as well as the color temperature) will be marked on the projector's OSD menu.

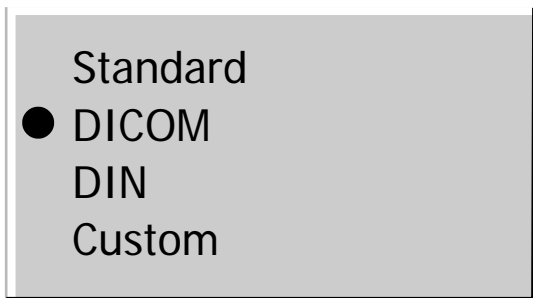

Image 10-5
Display function : active selection

The completion of the calibration procedure will in the same way be signaled by a separate logo (as well as for the color temperature).

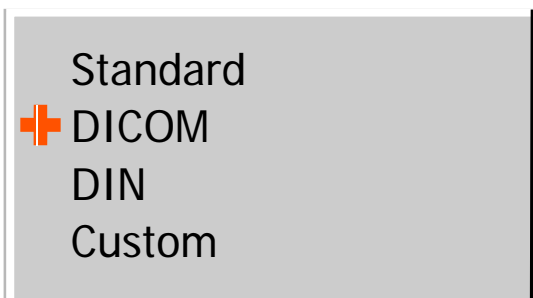

Image 10-6
Display function: calibrated

10.3 Restoring the factory settings

How to restore the factory settings for the display function and the color temperature ?

1. Press **MENU** to activate the Toolbar
2. Press → to select the *Settings* item
3. Press ↓ to Pull down the *Settings* menu
4. Use ↑ or ↓ to select *Factory reset* (image 10-7)
5. Press **ENTER**

The display function and color temperature are adapted and the corresponding LUT is loaded.



Image 10-7



Factory settings are “dark room” settings meaning they do not take account of environmental conditions (ambient light, glare,...).

10.4 Black and white selection

Build up of the Luminance signal Y

The color signals on the 5 BNC connectors can be chosen to be converted to a luminance signal **Y** in several ways. The contribution to the luminance signal can be chosen to be done by one or more color components.

Additionally, switching color components may accentuate some details and that way emphasize a part of the projected image.

Selection	Projected image	Comment	Image
RGB to RGB	color	-	image 10-8
G to Y	black & white	Green is replaced by white (bright)	image 10-11
RGB to Y	black & white	-	image 10-9
R to Y	black & white	Red is replaced by white (bright)	image 10-10
B to Y	black & white	Blue is replaced by white (bright)	image 10-12
RBG to Y	black & white	bars are repositioned	image 10-13
GRB to Y	black & white	bars are repositioned	-
GBR to Y	black & white	bars are repositioned	-
BRG to Y	black & white	bars are repositioned	-
BGR to Y	black & white	bars are repositioned	-

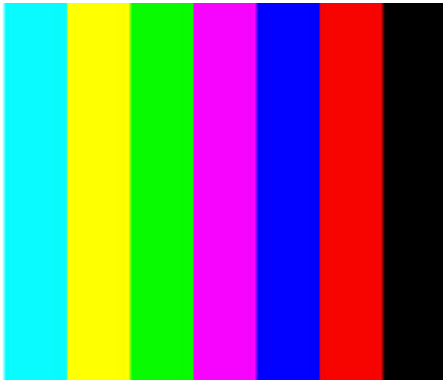

Image 10-8
RGB to RGB



Image 10-9
RGB to Y

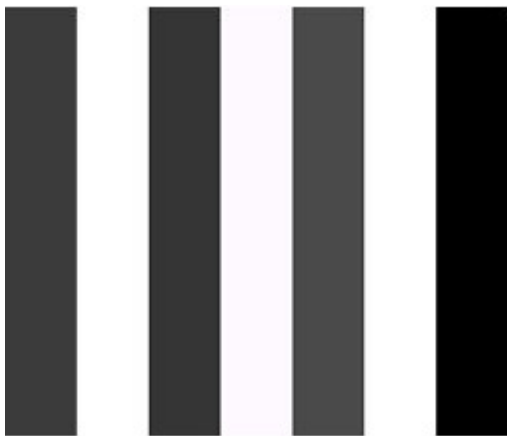

Image 10-10
R to Y



Image 10-11
G to Y



Image 10-12
B to Y



Image 10-13
RBG to Y

How to change the Black and White selection ?

1. Press **MENU** to activate the Toolbar
2. Press → to select the *Settings* item
3. Press ↓ to Pull down the menu
4. Use ↑ or ↓ to select *Black and White Selection* (image 10-14)
5. Press → to pull down the menu
6. Use ↑ or ↓ to select the desired selection
7. Press **ENTER**

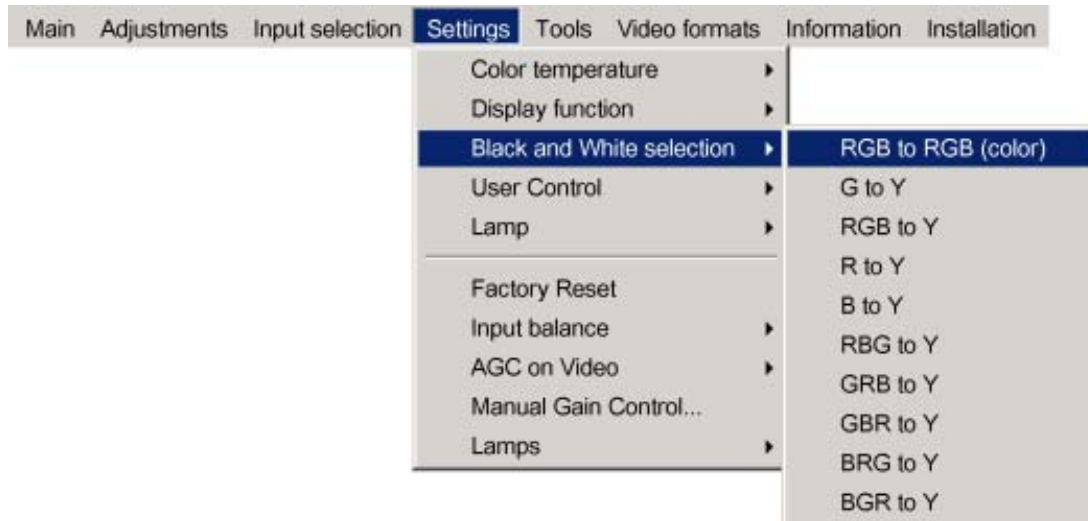

Image 10-14

10.5 User Control

What can be done ?

The *User control* parameter allows to lock the RCU, the commands coming from the RCU (or the executive RCU) are then ignored in the projector.

This can be used to prevent unauthorized adjustment of projector parameters.

How to lock the RCU ?

1. Press **MENU** to activate the Toolbar
2. Press → to select the *Settings* item
3. Press ↓ to Pull down the menu
4. Use ↑ or ↓ to select *User Control* (image 10-15)
5. Press → to pull down the menu
6. Use ↑ or ↓ to select ON or OFF
7. Press **ENTER**



Image 10-15

How to unlock the RCU once locked ?

Following password has to be entered on the RCU or on the executive RCU:

1. Enter the "More..." password (password used to access advanced menu)

10.6 Lamp mode selection

What are the different lamp modes ?

Single mode

The projector will always switch to the lamp with the shortest runtime when the difference between the runtimes of lamp1 and lamp 2 reaches **100 hours**, switching from one lamp to another happens only at switching on of the projector and not during operation.

When the lamp fails or reaches its maximum runtime the projector switches automatically to the other lamp without interrupting the projection. The failure is logged and the lamp will never be initialized in the future.

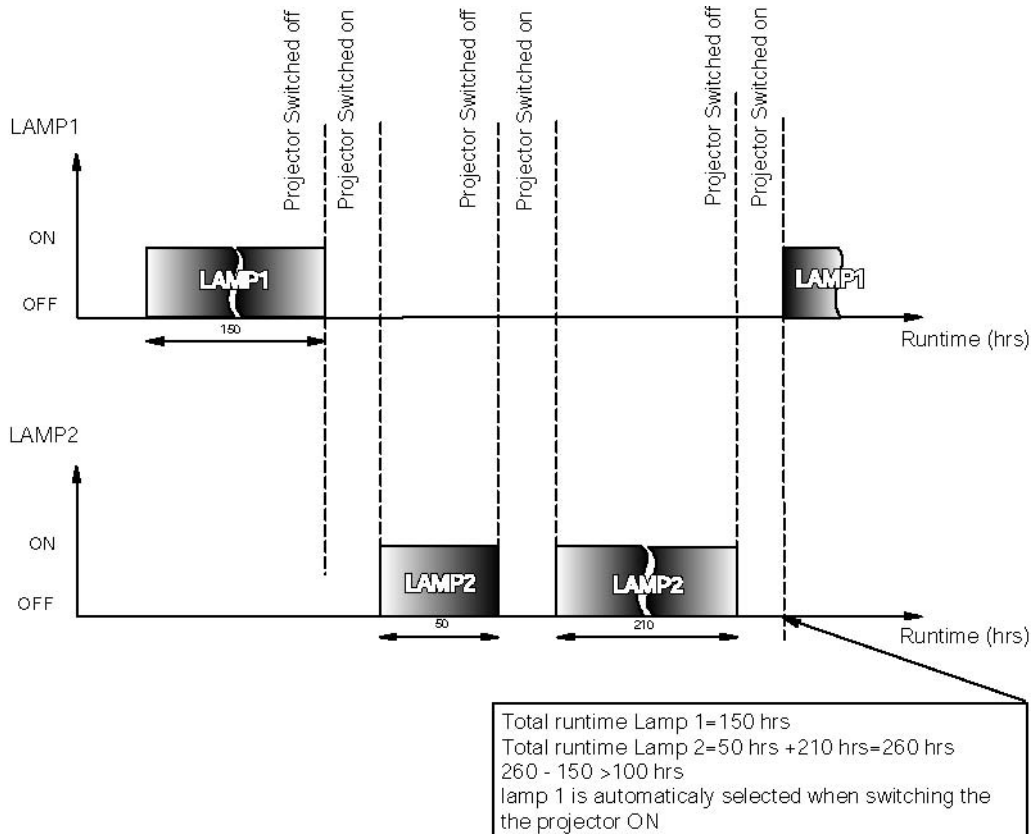

Image 10-16
 Single mode operation: switching principle

Dual mode

Both lamps are working.

When one lamp fails, the projector continues the projection using the remaining lamp.

How to select the lamp mode ?

1. Press **MENU** to activate the Toolbar
2. Press **→** to select the *Settings* item
3. Press **↓** to Pull down the menu
4. Use **↑** or **↓** to select *Lamp*
5. Press **→** to pull down the menu
6. Use **↑** or **↓** to select the mode (image 10-17)
7. Press **ENTER**

A bullet shows the active mode.

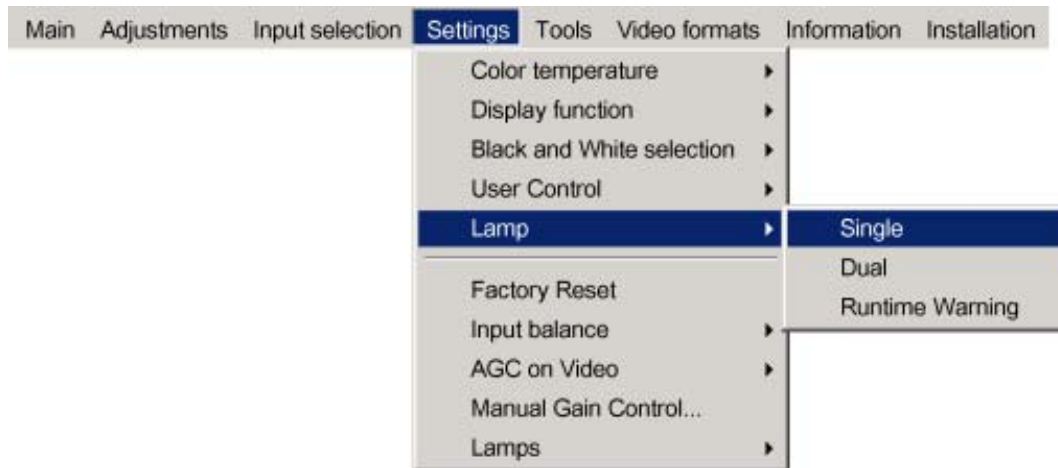

Image 10-17

10.7 Runtime warning

What can be done ?

When the lamp has reached a certain predetermined runtime , a warning message will be displayed on the screen. The lamp runtime warning can be set in a range from 30 to 200 hours. The runtime warning is displayed by default at 30 hours before end of lamp lifetime.

How to set the lamp runtime warning?

1. Press **MENU** to activate the Toolbar
2. Press → to select the *Settings* item
3. Press ↓ to Pull down the menu
4. Use ↑ or ↓ to select *Lamp*
5. Press → to open the *Lamp* menu
6. Use ↑ or ↓ to select *Runtime warning* (image 10-18)
7. Press **ENTER**

A dialogbox is displayed (image 10-19)

8. Use ←or →, the numeric keys on the remote, or the keypad to change the runtime warning setting.



Image 10-18

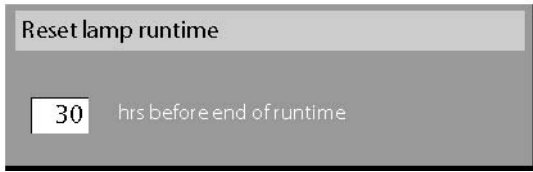

Image 10-19



WARNING: Lamp runtime reset as well as the lamp replacement can only be done by a Barco authorized technician.

10.8 Input Balance



CAUTION: The input balance adjustments are only for Barco authorized technicians !

Introduction: Unbalanced color signals

When transporting signals, there is always a risk of deterioration of the information contained in the signals.

In case of information contained in the amplitude of the signals which is the case of data color signals (R, G, B), image 10-20, we are quite sure that the amplitude of these color signals is subject to alterations.

An example of alteration may be a DC component added to the signal, in the form of a DC offset repositioning the black level, since this **black level** (“**brightness**”) will become crucial later on (clamping circuit) it will result in “black not being black”.

Another value that is subject to alteration is the amplitude of the signal, resulting in an altered “Gain” of the signal (“**white level**” or **contrast**).

The alterations of the three color signals will happen independently i.e. the colors will end to be unbalanced, image 10-21

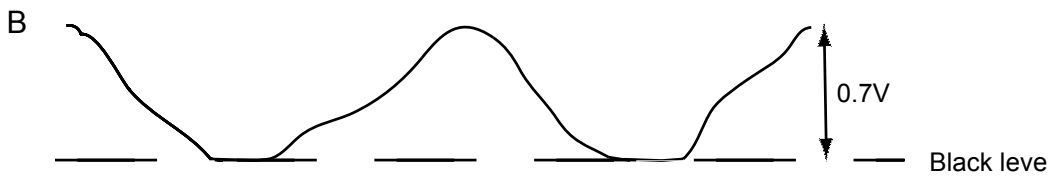

Image 10-20

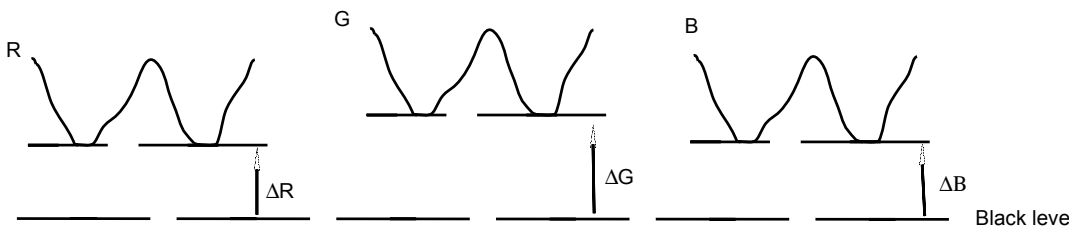

Image 10-21

Analog Digital Conversion

The analog color signals must pass through an Analog/Digital conversion circuit prior to any digital processing in the PMP.

A typical ADC transforms the analog value into an 8 bit coded digital signal.

The graphic shows that when converting a signal containing a DC offset component the range of the converter is not optimally used.

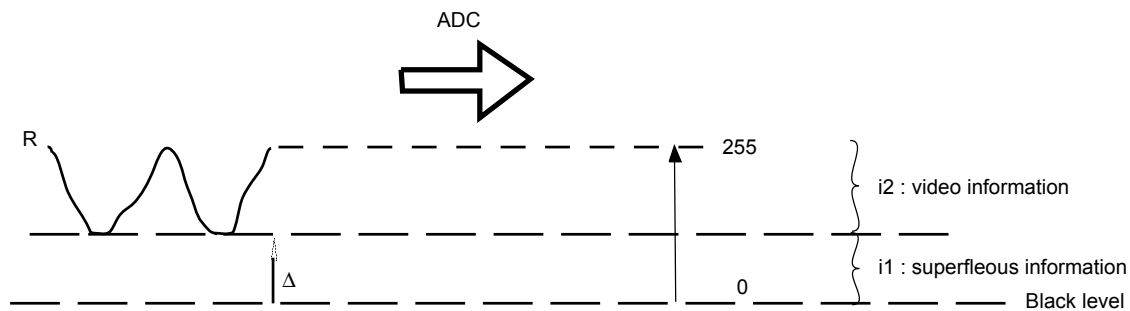

Image 10-22



One can conclude here that a good color tracking can only be met by using three previously (input) balanced color signals

The objective of input balancing

The objective in input balancing is to “set” the same black level and the same white level for the three colors of a particular input source.



Black level setting : brightness

White level setting : contrast

The same absolute black and white level for the three colors allows the same reference for Brightness and contrast control of the picture !

These two references also set the range in which the ADC will work for that particular source (this explains also why each input balance setting is linked to a particular source and thus saved in the image file).

How can it be done ?

To balance the three color signals of a particular source there are conditions; in fact we must know the black and the white level of the source i.e. :

1. the source in question must be able to generate a white signal, ideally a 100% white (background) full screen pattern
2. the source in question must be able to generate a black signal, ideally a 100 % black (background) full screen pattern

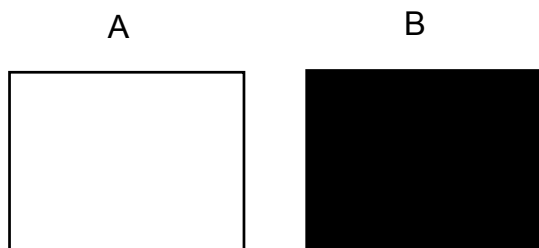

Image 10-23

White balance : In the projector, we will set the contrast for each color until we get a 100% light output picture when projecting a 100% white image (image A)

Black balance : In the projector, we will set the brightness for each color until we get a 0% light output picture when projecting a 100% black image (image B).



The changeover (transition) from min to max is indicated by the apparition of bright spots also called “digital noise”



An alternative to a full screen White/black pattern is the standard gray scale pattern, the white bar will be used for white balance and the black bar for black balance.



Image 10-24

Black balance

1. Press **MENU** to activate the Toolbar
2. Press → to select the *Image* item
3. Press ↓ to Pull down the *Image* menu
4. Use ↑ or ↓ to select *Input balance*
5. Press → to pull down the menu
6. Use ↓ or ↑ to select *Black balance* (image 10-25)
7. adjust the red black level on a minimal value (image 10-26, image 10-27)
8. adjust the blue black level on a minimal value
Note: *this minimal value is not necessary , provided that the 2 other colors are not influencing too much the color to be adjusted, in fact the aim is to minimize the effect of the two other colors since there is a risk of reaching too soon the transition due to the contribution of these two other color signals.*
9. Adjust the green black level until bright spots appear on the screen
- 10.adjust the blue black level on a minimal value
Note: *this minimal value is not necessary , provided that the 2 other colors are not influencing too much the color to be adjusted, in fact the aim is to minimize the effect of the two other colors since there is a risk of reaching too soon the transition due to the contribution of these two other color signals.*
- 11.Adjust the green black level until bright spots appear on the screen
- 12.Adjust the Blue black level until bright spots appear on the screen
- 13.Adjust the red black level until bright spots appear on the screen

The projected image should know be noisy full black

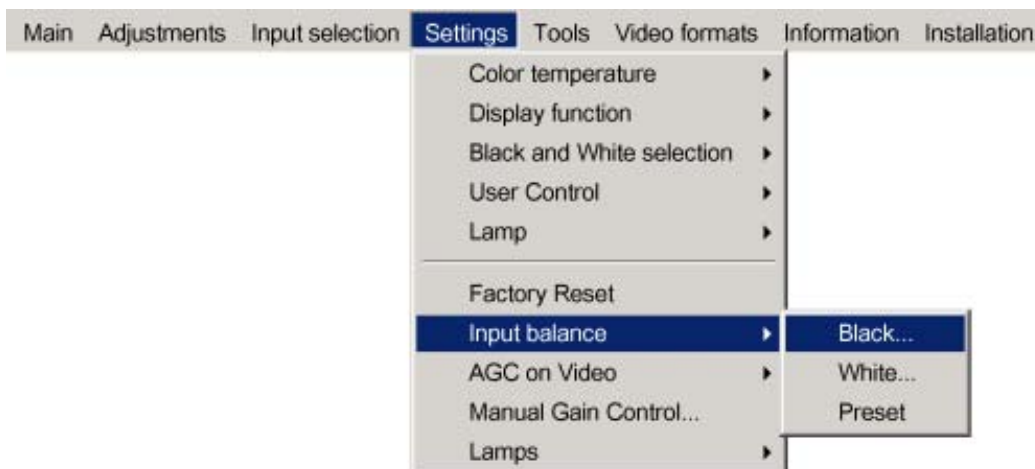

Image 10-25

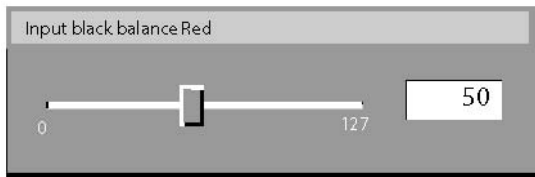

Image 10-26

Change color between Red, Green and Blue with < COLOR+>

Image 10-27

Performing White input balance

1. Connect the source you want to project
2. Select a white pattern (or gray scale as alternative)
3. Press **MENU** to activate the Toolbar
4. Press → to select the *Image* item
5. Press ↓ to Pull down the *Image* menu
6. Use ↑ or ↓ to select *Input balance*
7. Press → to pull down the menu
8. Use ↓ or ↑ to select *White balance* (image 10-28)
9. adjust the red white level (gain) on a minimal value (image 10-29)
10. adjust the blue white level (gain) on a minimal value

Note: *this minimal value is not necessary, provided that the 2 other colors are not influencing too much the color to be adjusted, in fact the aim is to minimize the effect of the two other colors since there is a risk of reaching too soon the transition (bright spots) due to the contribution of these two other colors signals.*

11. Adjust the Green white level (gain) until bright spots appear on the screen
12. Adjust the Blue white level (gain) until bright spots appear on the screen
13. Adjust the Red white level (gain) until bright spots appear on the screen
the projected image should know be noisy neutral grey.

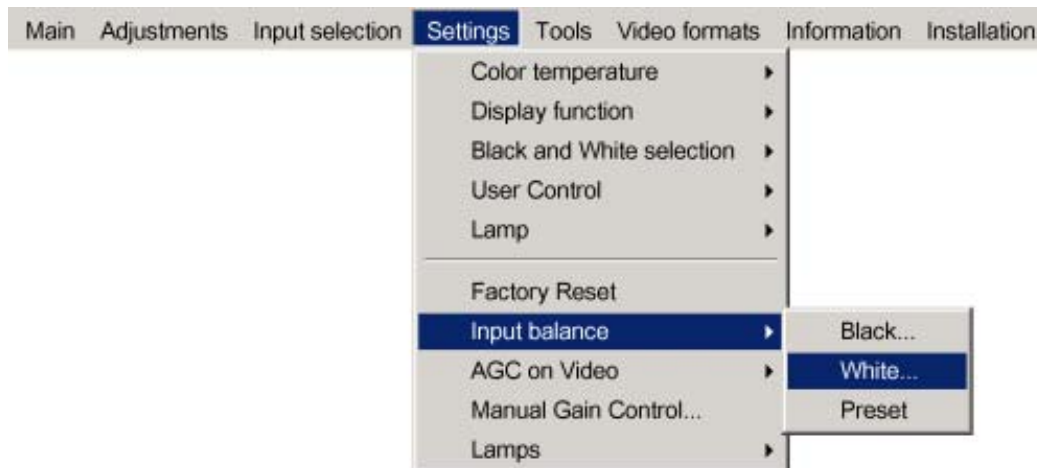

Image 10-28

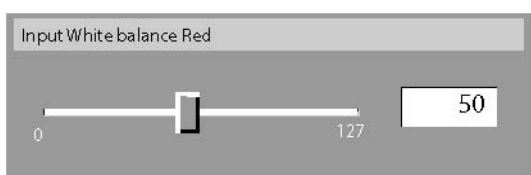

Image 10-29



if one uses a gray scale pattern, the bright spots should appear in the white bar.

10.9 AGC on Video



AGC

Automatic Gain Control: allows an automatic amplitude (gain) control of the incoming video signal



AGC is only for Video signals

Enabling/disabling the AGC

1. Press **MENU** to activate the Toolbar
2. Press → to select the *Settings* item
3. Press ↓ to Pull down the menu
4. Use ↑ or ↓ to select *AGC on Video*
5. Press → to pull down the menu
6. Use ↓ or ↑ to enable or disable the AGC
7. Press **ENTER**

A bullet shows the active setting (image 10-30)

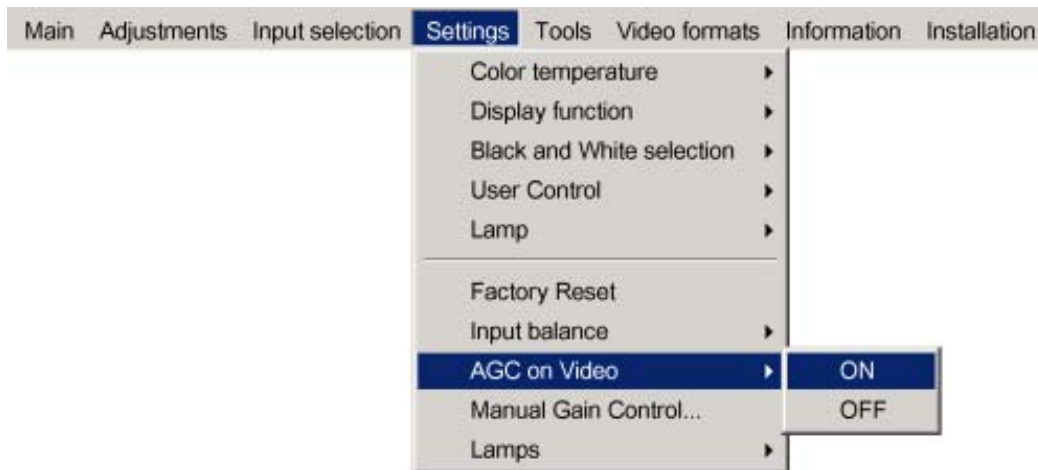

Image 10-30



The AGC can be disturbing in case of Macrovision encoded signals, therefore the AGC can be disabled (OFF) at any time

10.10 Manual Gain Control

What can be done ?

Beside the AGC there is the possibility to manually set the gain of the incoming video signal. When the AGC is enabled (ON), the manual setting does not affect the gain, AGC must therefore be disabled. The manual gain control must be done on an external pattern with white areas (grey scale bar pattern)

How to set the Manual Gain Control ?

1. Press **MENU** to activate the Toolbar
2. Press → to select the *Settings* item
3. Press ↓ to Pull down the menu
4. Use ↑ or ↓ to select *Manual Gain Control* (image 10-31)
5. Press **ENTER**
A scrollbar is displayed (image 10-32)
6. Use ← or →, the numeric keys on the remote, or the keypad to change the gain so as to obtain homogene white parts in the image.



Image 10-31

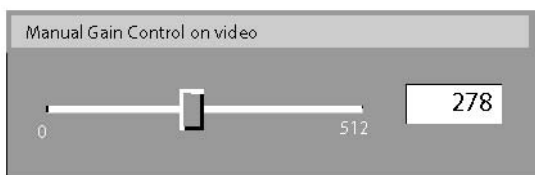

Image 10-32

10.11 Lamps

Overview

- History
- Reset runtime

10.11.1 History

How to view the history ?

1. Press **MENU** to activate the Toolbar
2. Press → to select the *Settings* item
3. Press ↓ to Pull down the menu
4. Use ↑ or ↓ to select *Lamps*
5. Press → to open the menu (image 10-33)
6. Use ↑ or ↓ to select *History*
7. Press **ENTER**
A textbox is displayed (image 10-34)

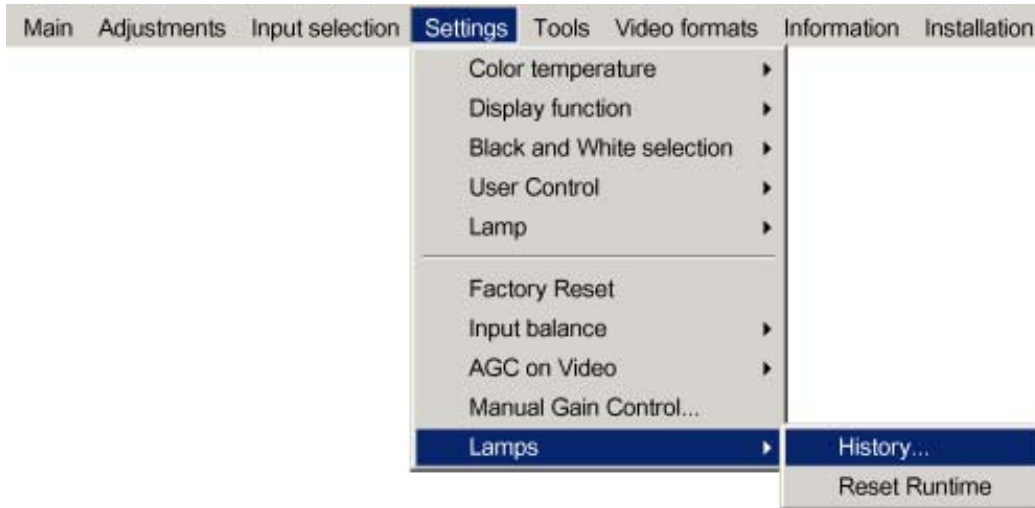

Image 10-33

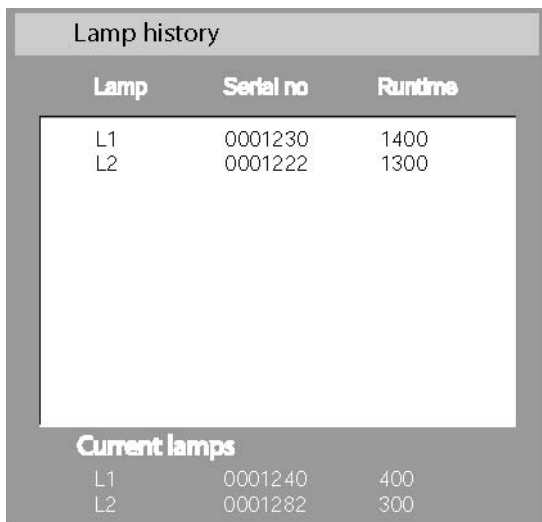

Image 10-34

10.11.2 Reset runtime

When to reset the lamp runtime ?

The lamp runtime should only be reset when placing a new lamp.

How to reset the lamp runtime ?

1. Press **MENU** to activate the Toolbar
2. Press → to select the *Settings* item
3. Press ↓ to Pull down the menu
4. Use ↑ or ↓ to select *Lamps*
5. Press → to pull down the menu
6. Use ↑ or ↓ to select *Reset Runtime*
7. Press → to open the menu
8. Use ↑ or ↓ to select the lamp to be reset (image 10-35)
9. Press **ENTER**

A dialogbox is displayed (image 10-36)
10. Use ← or →, the numeric keys on the remote, or the keypad to change the serial number of the lamp (serial number 0000000 will not be accepted).

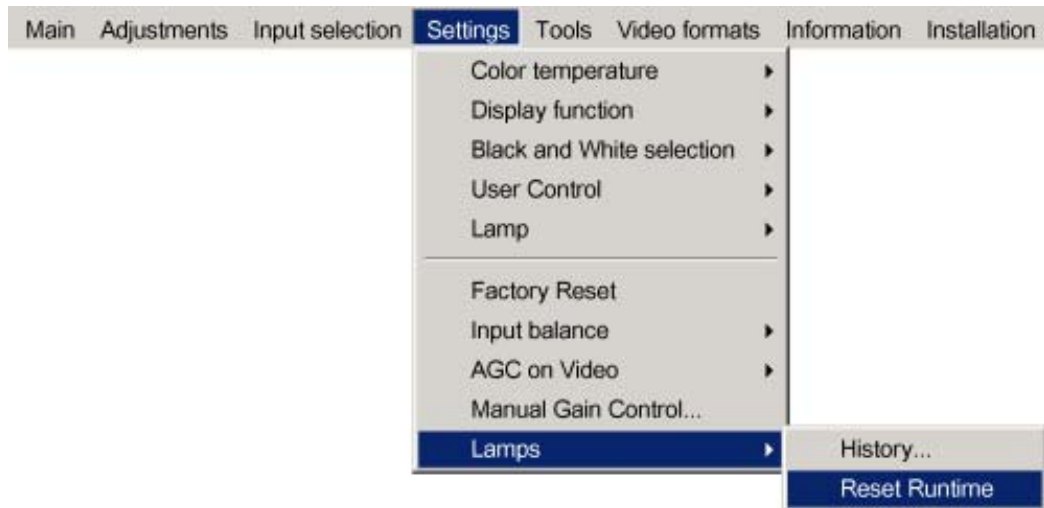

Image 10-35

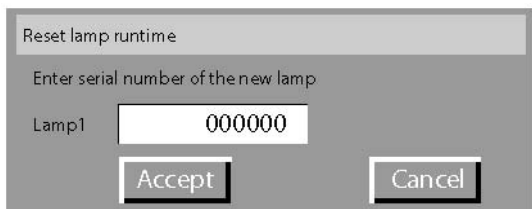

Image 10-36



WARNING: Lamp runtime reset as well as the lamp replacement can only be done by a Barco authorized technician.

11. TOOLS

Overview

- Source switching mode
- Picture in Picture
- PiP select
- Add window
- Remove window
- PiP Lay-out
- PiP Adjust
- Background
- Logo

11.1 Source switching mode

Switching from one source to another

To minimize undesired effects when switching from one source to another, one can use the Seamless switching mode, beside Seamless switching there is a wide choice of several effects which render the source switching transitions more enjoyable.

How to select a switching mode ?

1. Press **MENU** to activate the Toolbar
2. Press → to select the *Tools* item
3. Press ↓ to Pull down the menu
4. Use ↑ or ↓ to select *Source switching mode*
5. Press → to open the *Source switching mode* menu (image 11-1)
6. Press **ENTER**

The logo is displayed

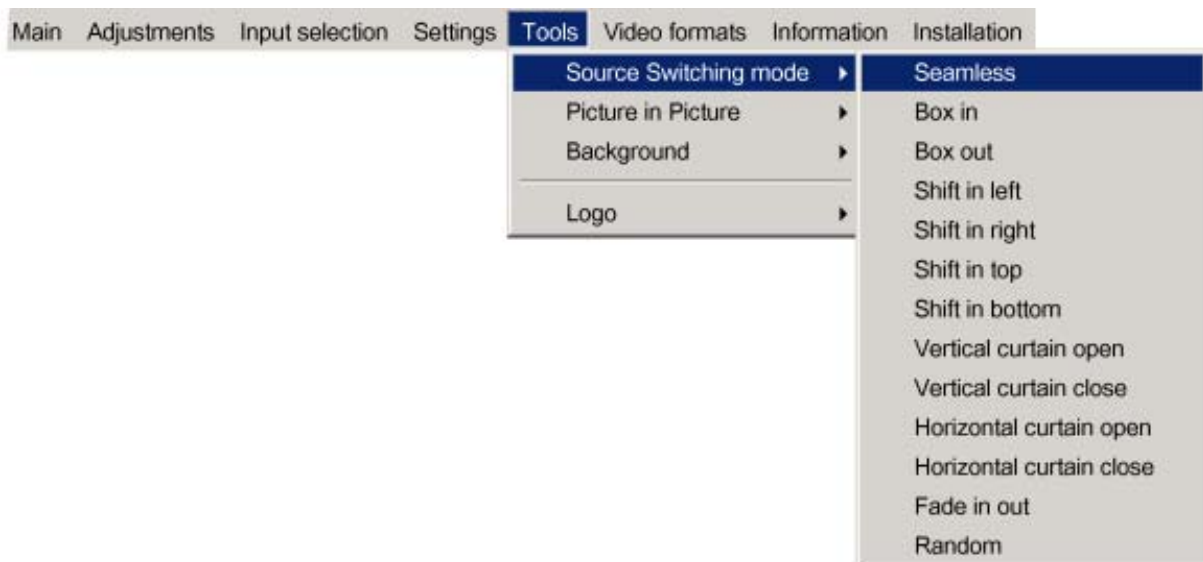

Image 11-1



The **Random** mode will select a new switching mode at each source switching i.e. there will never be 2 successive source switchings with the same effect.

The Seamless switching mode is not used in the **Random** mode.

Note on Fade in/out

In some cases, depending on the sources to be switched, the fade in/out effect is impossible or may not occur.

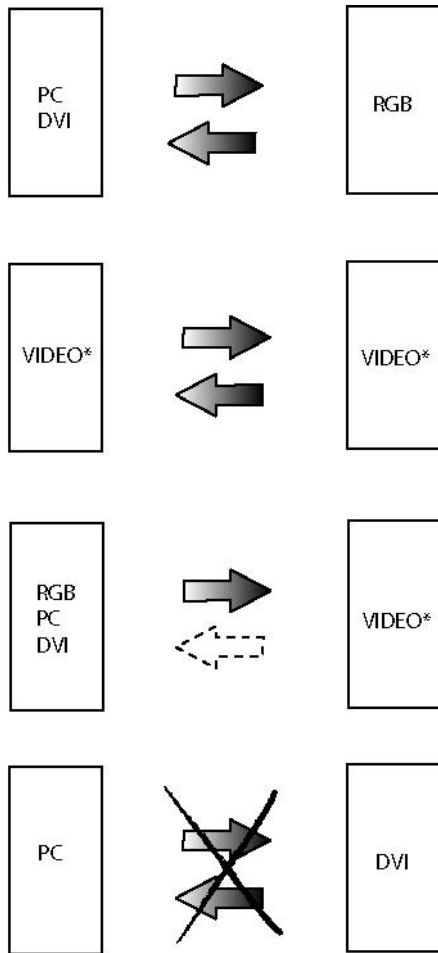

Image 11-2

* Video may be Composite video/ S-Video / SDI

- dark arrow : fade in/out effect possible
- dotted arrow : undetermined case, fade in/out effect may take place or not
- striked out arrow : fade effect impossible

11.2 Picture in Picture

11.2.1 Introduction to PiP



PiP

PiP stands for "Picture in Picture" and allows to display multiple windows containing each of them an image. The windows may be of the video or data type.

What are the different possibilities within the PiP mode ?

The input section of the projector allows a multitude of combinations of different input signals which may be projected in the 4 windows of the PiP screen.

The PiP mode allows independent settings for each window:

- Image settings : contrast, brightness, tint, color,...
- Vertical and horizontal shift of each window all over the screen
- Resizing of the window
- Digital Zoom

What are the different PiP configurations ?

- Full screen²

The full screen is used to display one of the selected sources.
Browsing through the sources is possible with the **PiP Adjust** button on the remote.

- 2 Landscape:²
2 sources are projected in landscape view mode.

The screen is divided into 2 subscreens containing 2 Data sources coming from the BNC and PC D15 input.

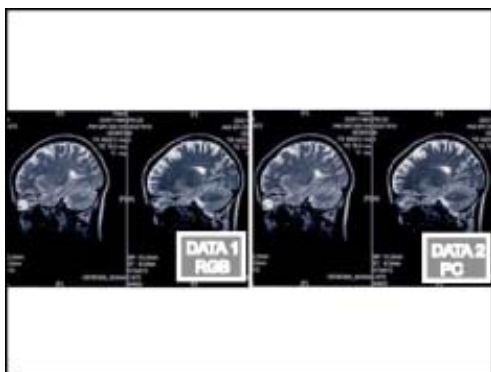

Image 11-3

- 2 Portrait:²
2 source are projected side by side in portrait view mode .
The screen is divided into 2 subscreens containing 2 Data sources coming from the BNC and PC D15 input.



Image 11-4

- Personal layouts

Beside the 3 factory layouts one can set up to 7 additional (personal) layouts.

11.2.2 Preferences

Setting a preferred layout

There is a possibility of memorising a particular layout.

The PiP key allows then the switching between *Full screen* and the memorised layout.

How to set a preferred layout ?

1. Press **MENU** to activate the Toolbar
2. Press → to select the *Tools* item
3. Press ↓ to Pull down the *Tools* menu
4. Use ↑ or ↓ to select Picture in Picture
5. Press → to pull down the menu
6. Use ↑ or ↓ to select the *PIP Select*

² factory layout

11. Tools

7. Press → to pull down the menu
8. Use ↑ or ↓ to select the desired configuration (image 11-5)
9. Press **PIP** on the RCU or on the executive RCU for at least **3** seconds (image 11-6)
The layout is memorized as the preferred layout.
A bullet shows the active layout.

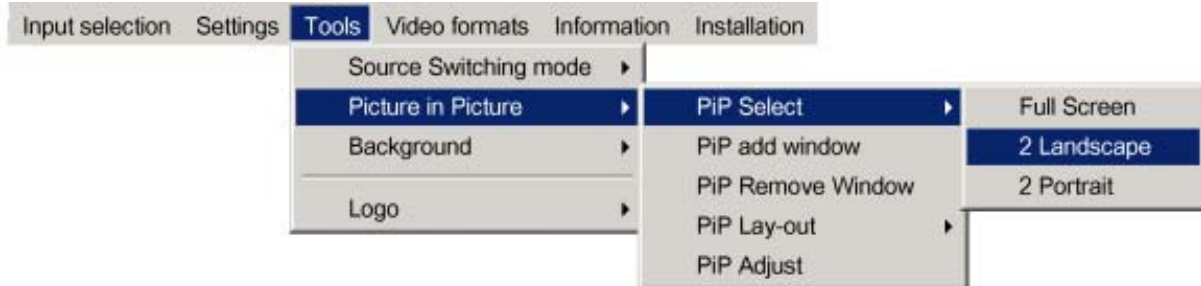

Image 11-5

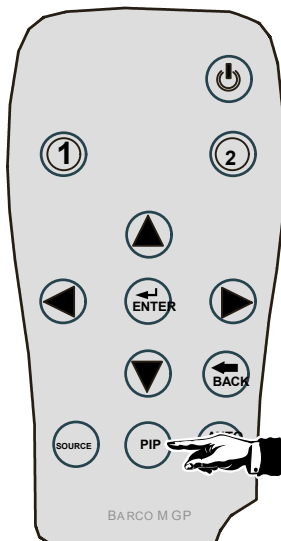

Image 11-6



The PiP key allows now to switch between *Full screen* and the memorized layout.

11.3 PiP select

How to change the PiP configuration ?

1. Press **MENU** to activate the Toolbar
2. Press → to select the *Tools* item
3. Press ↓ to Pull down the *Tools* menu
4. Use ↑ or ↓ to select *Picture in Picture*
5. Press → to pull down the menu
6. Use ↑ or ↓ to select the *PiP Select*
7. Press → to pull down the menu

8. Use ↑ or ↓ to select the desired configuration (image 11-7)
9. Press **ENTER**
A bullet shows the active layout

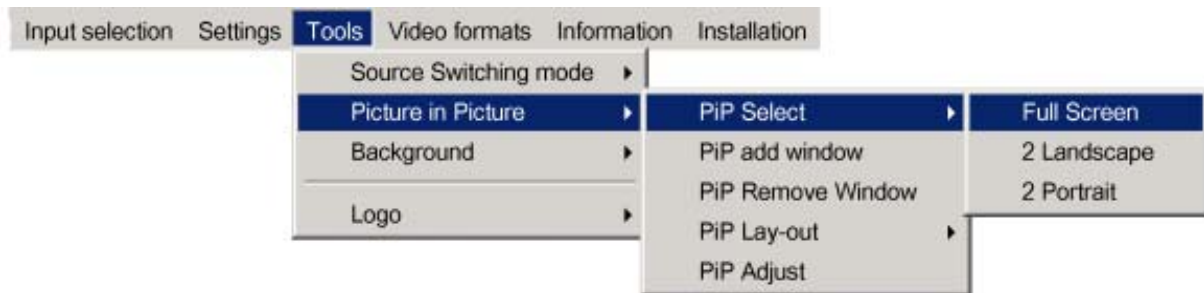

Image 11-7

11.4 Add window

What can be done ?

It is possible to add a window to the existing windows (maximum 4), therefore a source must be selected.

Sources which are already used are unselectable. If for instance the PiP layout contains a component video then component video will be unselectable.

Once added, the window may be altered in several ways to meet particular needs:

- repositioning
- re-sizing
- changing the order

How to add a window ?

1. Press **MENU** to activate the Toolbar
2. Press → to select the *Tools* item
3. Press ↓ to Pull down the *Tools* menu
4. Use ↑ or ↓ to select Picture in Picture
5. Press → to pull down the menu
6. Use ↑ or ↓ to select *PiP add window* (image 11-8)
7. Press **ENTER**

The source selection menu is displayed (image 11-9)

In the lower part of the screen appears a wizard in 4 steps (image 11-10)

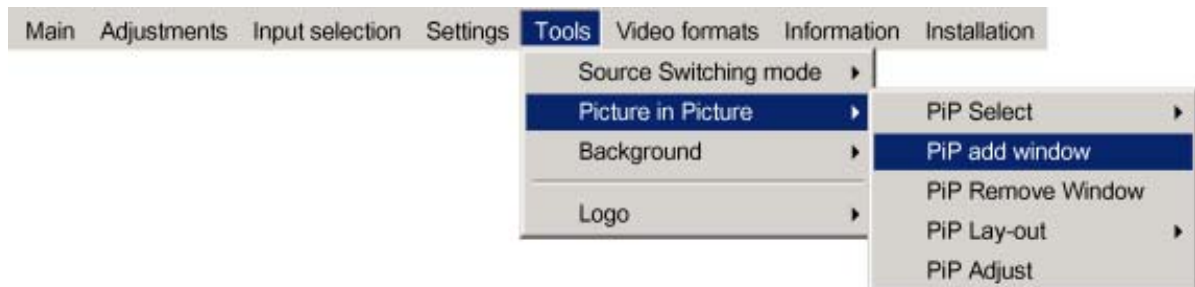

Image 11-8

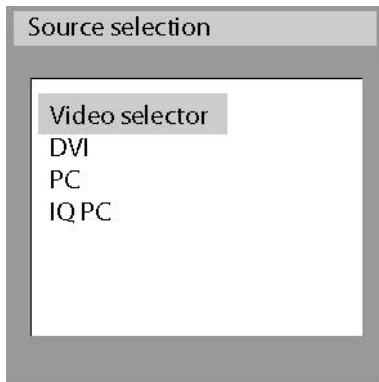

Image 11-9

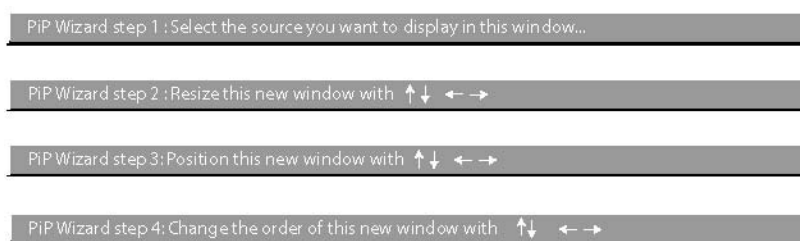

Image 11-10

11.5 Remove window

How to remove a window ?

1. Press **MENU** to activate the Toolbar
2. Press **→** to select the *Tools* item
3. Press **↓** to Pull down the *Tools* menu
4. Use **↑** or **↓** to select *Picture in Picture*
5. Press **→** to pull down the menu
6. Use **↑** or **↓** to select *PIP remove window* (image 11-11)
7. Press **ENTER**

The source selection menu is displayed (image 11-12)

In the lower part of the screen appears a wizard in 4 steps (image 11-13)

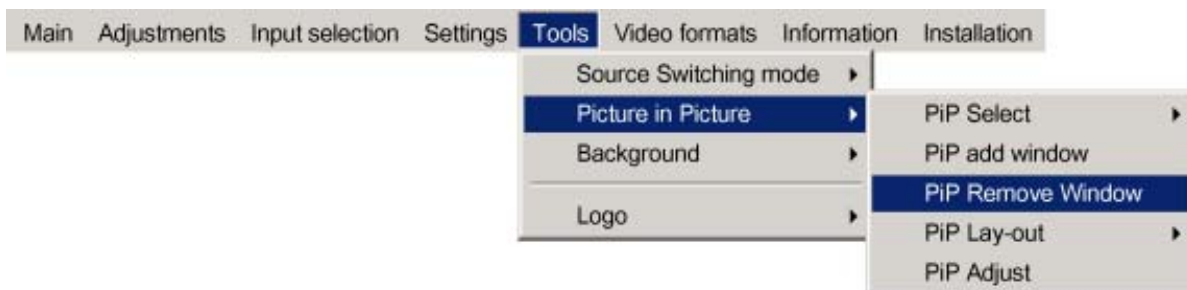

Image 11-11

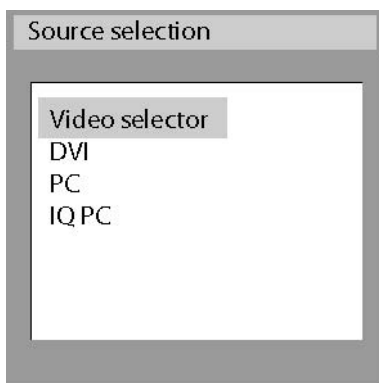

Image 11-12

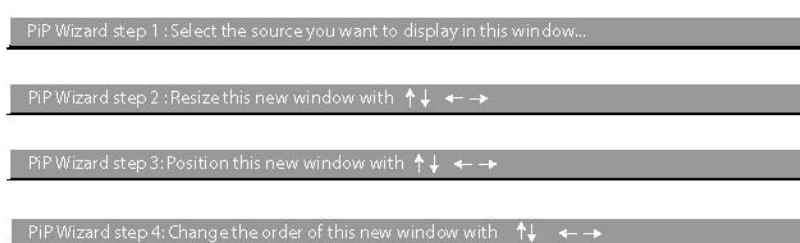

Image 11-13

11.6 PiP Lay-out

Overview

- PiP Save
- PiP rename layout
- PiP delete layout

11.6.1 PiP Save

What can be done ?

The active layout can be saved or "saved as".

When a new layout is saved it is added to the *PiP select* menu.



A fixed layout can be edited (resizing, repositioning,...) but it can not be saved under its original name.

How to save a layout ?

1. Press **MENU** to activate the Toolbar
2. Press → to select the *Tools* item
3. Press ↓ to Pull down the *Tools* menu
4. Use ↑ or ↓ to select *Picture in Picture*
5. Press → to pull down the menu
6. Use ↑ or ↓ to select *PiP layout*
7. Press → to pull down the menu
8. Use ↑ or ↓ to select *PiP save* or *save as* (image 11-14)
9. Press **ENTER**

If *save as* has been selected, a dialogbox is displayed (image 11-15)

Use ← or →, the numeric keys on the remote, or the keypad to enter the name and exit with **BACK** or **MENU**.

If *save* has been selected, a messagebox is displayed (image 11-16)

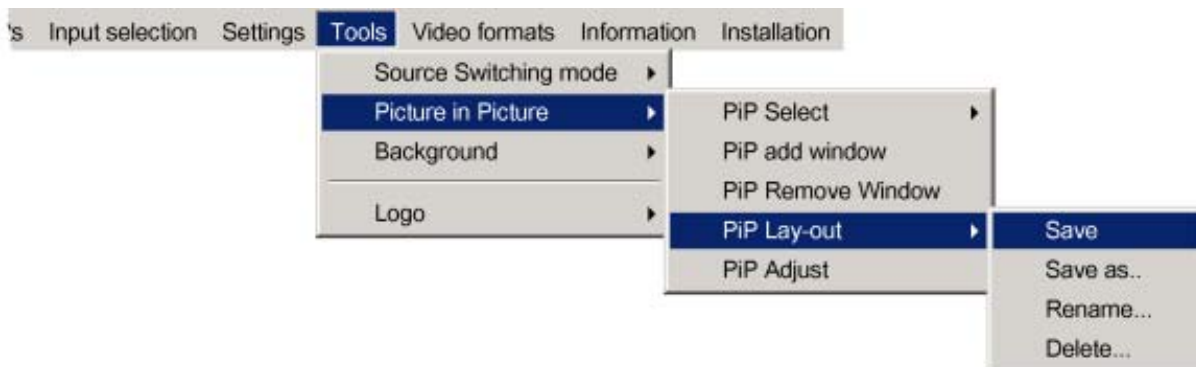

Image 11-14

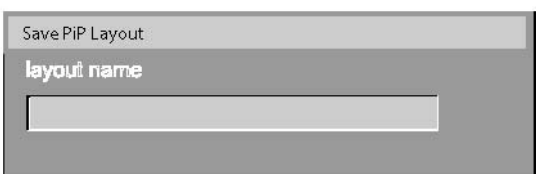

Image 11-15



Image 11-16

11.6.2 PiP rename layout

What can be done ?

The non fixed layouts (personal layouts) can be renamed .

The maximal length of the name is 12 characters.



A fixed layout can not be renamed

How to rename a layout ?

1. Press **MENU** to activate the Toolbar
2. Press → to select the *Tools* item
3. Press ↓ to Pull down the *Tools* menu
4. Use ↑ or ↓ to select *Picture in Picture*
5. Press → to pull down the menu
6. Use ↑ or ↓ to select *PiP layout*
7. Press → to pull down the menu
8. Use ↑ or ↓ to select *Rename*
9. Press **ENTER**

A dialogbox is displayed (image 11-17)

10. Use ↑ or ↓ to select the layout to be renamed

11. Press **ENTER**

A dialogbox is displayed (image 11-18)

Use ← or →, the numeric keys on the remote, or the keypad to enter the name and exit with **BACK** or **MENU**.

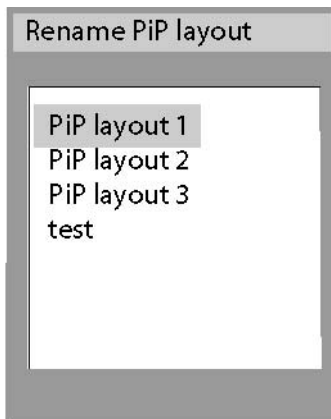

Image 11-17

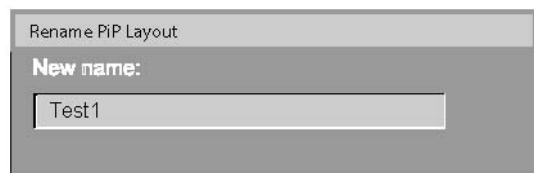

Image 11-18

11.6.3 PiP delete layout

What can be done ?

The non fixed layouts (factory and personal layouts) can be deleted.



The fixed layouts and the active layout can not be deleted.

How to delete a layout ?

1. Press **MENU** to activate the Toolbar
2. Press → to select the *Tools* item
3. Press ↓ to Pull down the *Tools* menu

4. Use ↑ or ↓ to select *Picture in Picture*
 5. Press → to pull down the menu
 6. Use ↑ or ↓ to select *PiP layout*
 7. Press → to pull down the menu
 8. Use ↑ or ↓ to select *Delete*
 9. Press **ENTER**
- A dialogbox is displayed (image 11-19)
10. Use ↑ or ↓ to select the layout to be renamed
 11. Press **ENTER**

The layout is deleted and disappears from the dialogbox.

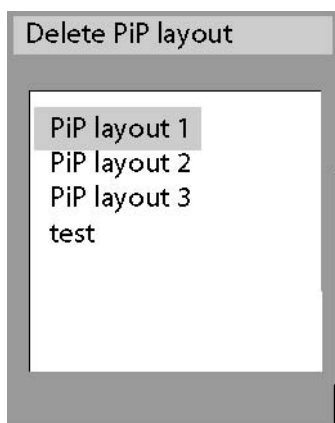

Image 11-19

11.7 PiP Adjust

What can be done ?

PiP adjust allows to browse through the windows in the active layout, a white frame indicates the window which has the focus. This way, independent settings (picture settings, ...) are possible for each window.



This can also be done by using the dedicated PiP Adjust key on the RCU

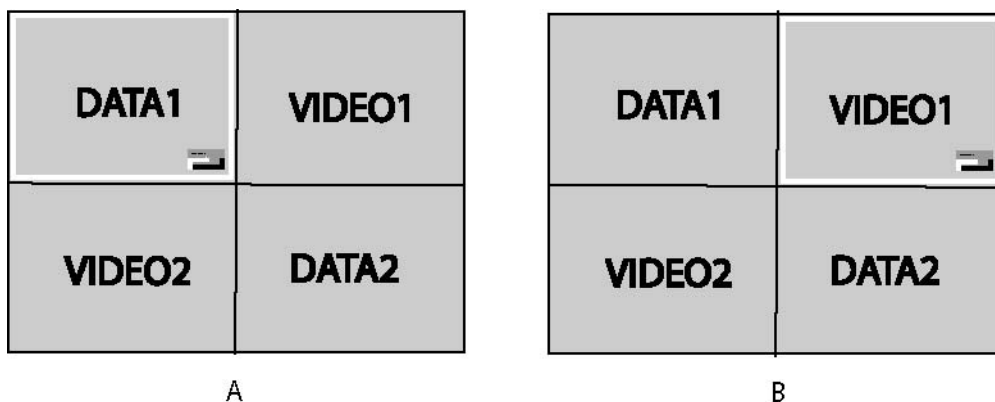

Image 11-20
PiP adjust in case a particular 4 window layout

- A Data1 window has the focus, new settings will only affect Data1 window
- B Video1 window has the focus, new settings will only affect Video1 window

PiP adjust

1. Press **MENU** to activate the Toolbar
2. Press → to select the *Tools* item
3. Press ↓ to Pull down the *Tools* menu
4. Use ↑ or ↓ to select *Picture in Picture*
5. Press → to open the menu
6. Use ↑ or ↓ to select *PiP Adjust* (image 11-21)
7. Press **ENTER**
The menu disappears and the source box is displayed
The focus moves to the next window when pressing **ENTER** (clockwise rotation)
If you press **BACK** or if you wait 5 seconds the menu is displayed.

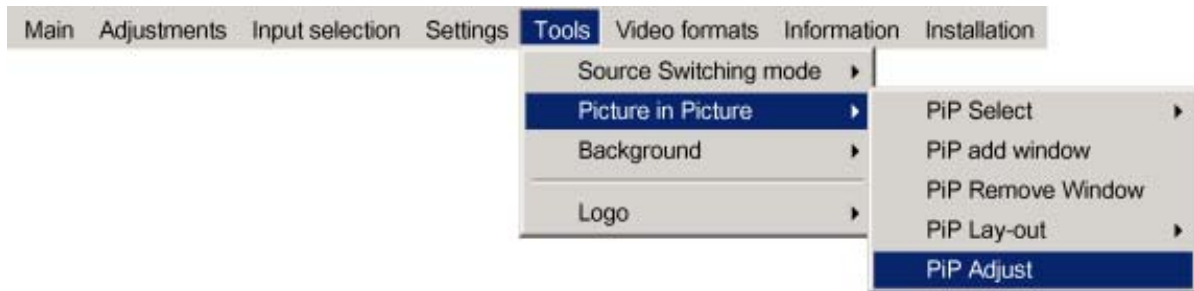

Image 11-21

How to adjust a window in the layout ?

1. Use the PiP Adjust key or function in the menu to choose the window to be adjusted
2. Press **ENTER**
A wizard bar is displayed in the bottom of the screen
Follow the procedure.

11.8 Background

Purpose

If there is no signal connected to the projector, the background will be a logo, a black or a blue screen depending on the *background* settings.

How to change the background ?

1. Press **MENU** to activate the Toolbar
2. Press → to select the *Tools* item
3. Press ↓ to Pull down the *Tools* menu
4. Use ↑ or ↓ to select *Background*
5. Press → to pull down the menu
6. Use ↑ or ↓ to select the desired background (image 11-22)
7. Press **ENTER**

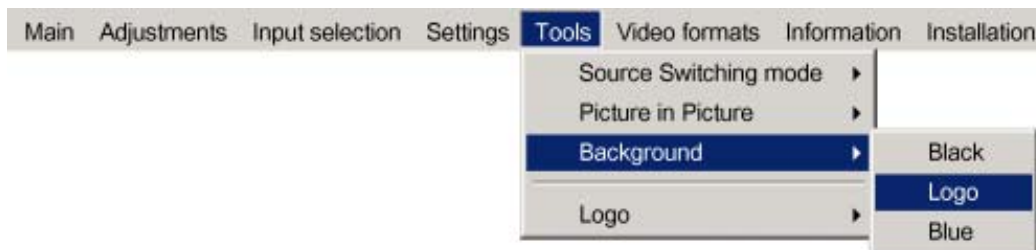

Image 11-22



The logo display is only possible in the full screen mode, a logo can thus not be displayed (rescaled) in a window in the PiP mode.



When there is no signal connected, the projector will also start its standby timer countdown (if enabled) and shuts down after the predetermined time.

11.9 Logo

What can be done ?

A screenshot can be taken from an active projected image. This screenshot is then saved and can be used as background. Each new screenshot erases the previous logo, therefore a warning message is displayed asking the user to confirm.

How to take a screenshot ?

1. Press **MENU** to activate the Toolbar
2. Press → to select the *Tools* item
3. Press ↓ to Pull down the menu
4. Use ↑ or ↓ to select *Logo*
5. Press → to open the menu
6. Use ↑ or ↓ to select *Take screenshot* (image 11-23)
7. Press **ENTER**

A dialogbox is displayed. Press **yes** to confirm. (image 11-24)

A textbox shows the evolution of the operation. (image 11-25, image 11-26)



Image 11-23

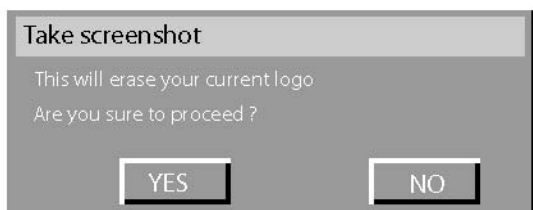

Image 11-24

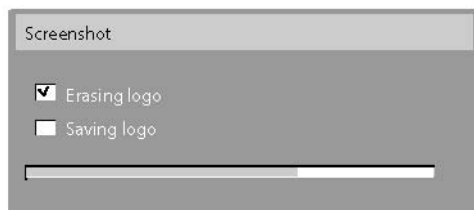

Image 11-25

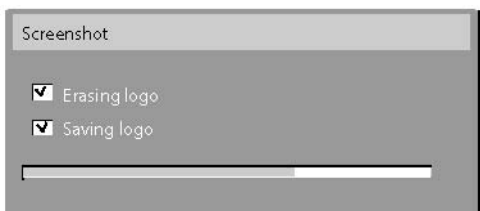

Image 11-26

12. VIDEO FORMATS

Overview

- Introduction
- Load
- Edit
- Rename
- Copy
- Delete

12.1 Introduction

Introduction to video formats

An image file contains the main characteristics of a source (number of active lines,...). The projector's memory contains a list of files corresponding to the most common sources, these are the standard files (file extension= *.s). When a new source corresponds to one of these files, a custom file (file extension=*.C) is created and saved for future use.

The maximum number of custom files that can be created is 99, the four last files are systematically overwritten.

When there is a little difference, the file can also be loaded and then edited until the source specs are reached.



The Autosetup (Autolmage) function creates automatically the best suited image file (custom file) for a new source. Autosetup is used when:

- a new source is detected : Autosetup creates a new custom file which can always be edited if necessary.
- the Autolmage button on the RCU is pressed

Autolmage works only in full screen mode



If the Autolmage function does not succeed in finding a file and no file is loaded (load list is empty), which means that the source is not displayed, then use the *copy* function,

Possible file manipulations

The possible file manipulations are :

- Load : installation of a file for a new source
- Edit : editing a loaded file to match the source specifications
- Rename : renaming a file
- Copy : copying a file to a new file
- Delete : deleting an existing file

12.2 Load

How to load a file ?

1. Press **MENU** to activate the Toolbar
2. Press → to select the *Video format* item
3. Press ↓ to Pull down the menu
4. Use ↑ or ↓ to select *Load format* (image 12-1)
5. Press **ENTER**
A dialogbox is displayed (image 12-2)
6. Use ↑ or ↓ to select the desired file
7. Press **ENTER**

The file is loaded and the image is adapted.



Image 12-1

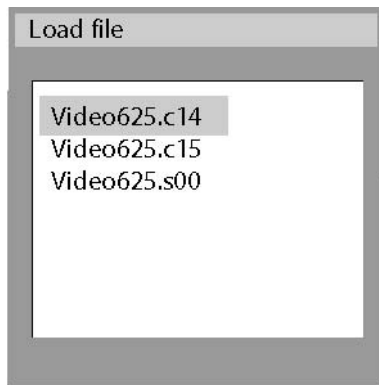

Image 12-2
load file dialogbox in case of a video source



In PiP mode, the files which may be loaded will be of the data type if the active window is a data window, or they will be of the video type if the active window is a video window.

What to do if the image is not perfect ?

If the displayed image is not correct after AutoImage or after selecting the best fitting file, go to the Edit menu, select the active file and change the settings.

12.3 Edit

What can be done with the Edit file menu ?

The Edit file menu makes it possible to change the settings of the file according to the real settings of the connected source. Consult the source specifications before entering the data.

How to edit a file ?

1. Press **MENU** to activate the Toolbar
2. Press → to select the *Video format* item
3. Press ↓ to Pull down the *Video format* menu
4. Use ↑ or ↓ to select *Edit* (image 12-3)
5. Press **ENTER**
A dialogbox is displayed
6. Use ↑ or ↓ to select the desired file
Note: *If in PiP mode the cursor is placed by default on the active file which has the focus.*
7. Press **ENTER**
A dialogbox is displayed (image 12-4)
8. Press **ENTER**
A dialogbox is displayed (image 12-5)
9. Use ← or →, the numeric keys on the remote, or the keypad to edit and change the values, confirm with **ENTER**
Note: *greyed out fields can not be updated (total pixels)*



Image 12-3

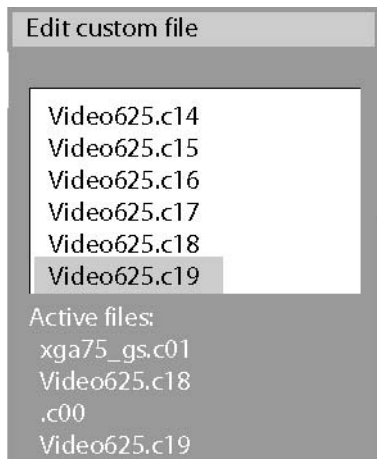

Image 12-4

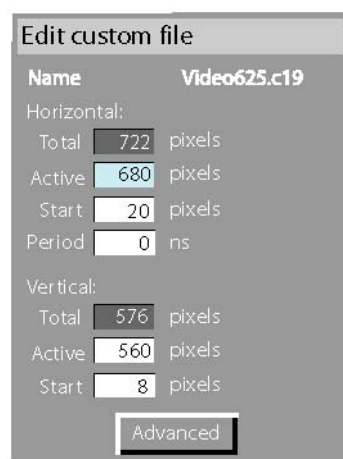

Image 12-5

Which items can be adjusted ?

The following items can be adjusted :

- Active horizontal pixels
- Horizontal start in pixels
- Horizontal period in ns
- Active vertical lines
- Vertical start in lines

Advanced video settings

The **advanced** button enables the advanced settings for a video source.

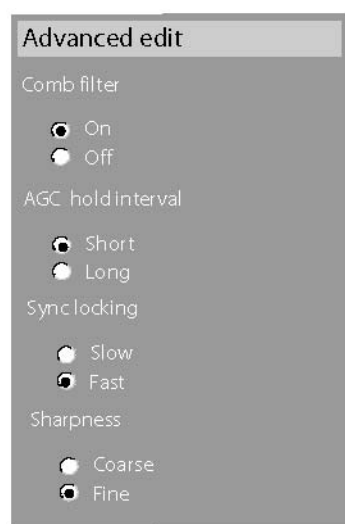

Image 12-6

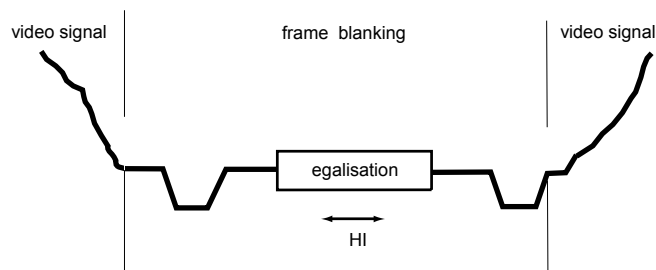

Image 12-7
HI AGC Hold interval

The **Comb filter** is by default enabled.

12. Video formats

The **AGC hold interval** is the time interval in which the AGC is inhibited (AGC hold = no update in video amplitude measurement), the advanced parameter allows to choose a short or long hold interval.

A long AGC hold interval eliminates Macrovision® disturbances since the AGC is hold during a long interval, thus reducing the probability to encounter a Macrovision® pulse.

The **sync locking setting** is recommended for poor video signals (ex: poor TV signals).

Sharpness adjustment can be chosen to be coarse or fine.



It is recommended to use the default values.

Advanced Data settings

The **advanced** button enables the advanced settings for a data source.

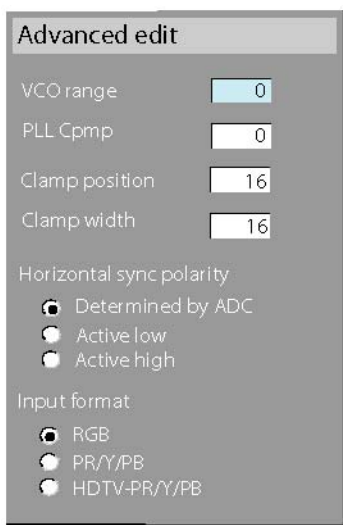

Image 12-8

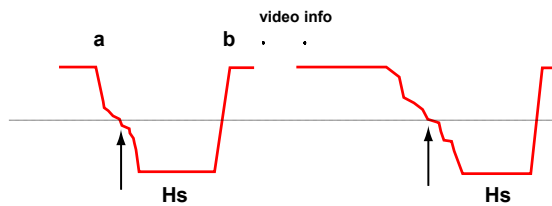

Image 12-9
Hs horizontal sync pulse
a active low
b active high

The **VCO range** setting determines the frequency range of the VCO (Voltage Controlled Oscillator).

The **Cmp** (Charge pump current) sets the low pass filter current.

Both VCO range & Cmp are set by the image file, changing these settings is only indicated for special purposes.

The **horizontal sync polarity** setting can be useful in case of a bad shaped edge, one can choose between the leading (active low) or trailing (active high) edge.

The input format settings are used to "tell more" about the signals connected on the BNC's, it completes the information in the source selection menu.

- RGB is selected by default and means that an RGB signal is connected to the BNC's

- PR/Y/PB must be selected whenever:

- a progressive signal (32 kHz frequency video signal) is connected to the BNC's (select the source with *Data on BNC's* in the Source selection menu).
- one wants (in PiP mode) to visualize the component video signal in a Data window hereby adding a video image in the PiP layout.

-HDTV-PR/Y/PB for high definition component video signals.

12.4 Rename

How to rename a file ?

1. Press **MENU** to activate the Toolbar
2. Press → to select the *Video format* item
3. Press ↓ to Pull down the *Video format* menu
4. Use ↑ or ↓ to select *Rename*

5. Press **ENTER**
A dialogbox is displayed (image 12-10)
6. Use ↑ or ↓ to select the desired file
7. Press **ENTER**
A textbox is displayed (image 12-11)
Use ← or →, ↓ or ↑ the numeric keys on the remote, or the keypad to edit and change the values, confirm with **ENTER**.

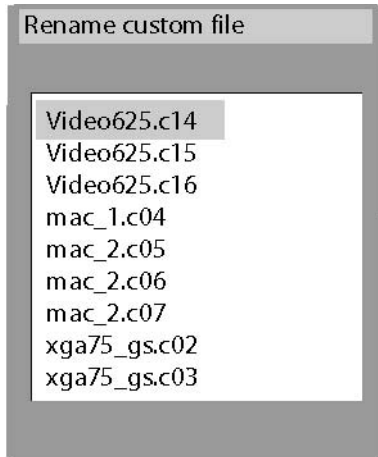

Image 12-10

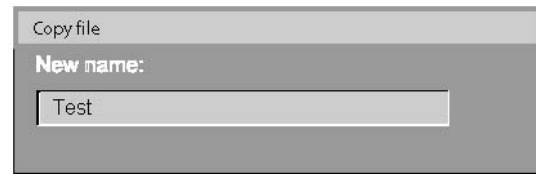

Image 12-11

12.5 Copy

How to copy a file ?

1. Press **MENU** to activate the Toolbar
2. Press → to select the *Video format* item
3. Press ↓ to Pull down the *Video format* menu
4. Use ↑ or ↓ to select *copy* (image 12-12)
5. Press **ENTER**
A dialogbox is displayed (image 12-13)
6. Use ↑ or ↓ to select the desired file
7. Press **ENTER**
A textbox is displayed (image 12-14)
Use ← or →, ↓ or ↑ on the remote, or the keypad to enter the new name, confirm with **ENTER**.

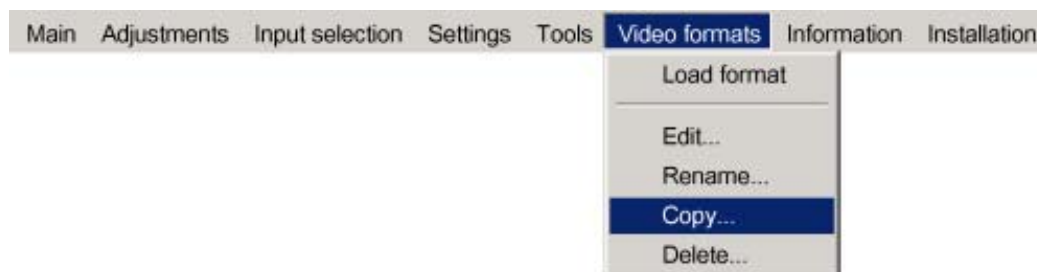

Image 12-12

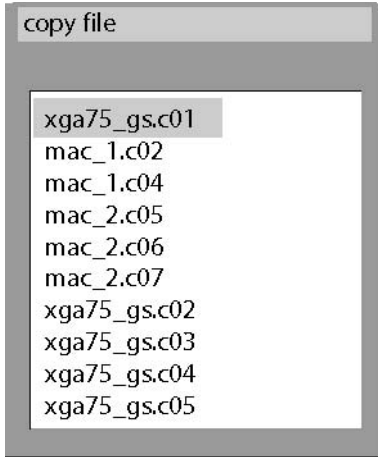

Image 12-13

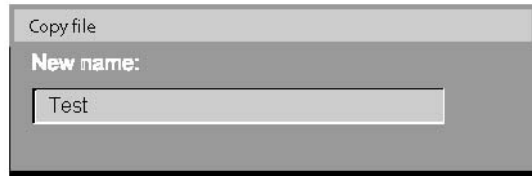

Image 12-14



If the AutoSetup function does not succeed in finding a file and no file is loaded (load list is empty), which means that the source is not displayed, then use the *copy* function: Copy a standard file (.std) which is not too different of the source to display, then edit this file to get the best image.

12.6 Delete

How to delete a file ?

1. Press **MENU** to activate the Toolbar
2. Press → to select the *Video format* item
3. Press ↓ to Pull down the *Video format* menu
4. Use ↑ or ↓ to select *Delete* (image 12-15)
5. Press **ENTER**
A dialogbox is displayed (image 12-16)
6. Use ↑ or ↓ to select the desired file
7. Press **ENTER**
The selected file is deleted and is removed from the list



Image 12-15

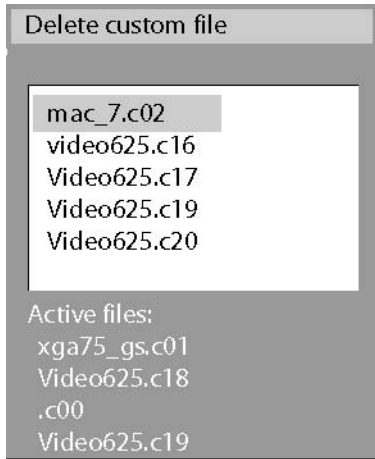

Image 12-16

13. INFORMATION

Overview

- Product identification
- Configuration
- Runtimes
- Current Input format
- Diagnostics
- Quick acces keys

13.1 Product identification

How to display the identification screen ?

1. Press **MENU** to activate the Toolbar
2. Press → to select *Information*
3. Press ↓ to Pull down the menu
4. Use ↑ or ↓ to select *Product identification* (image 13-1)
5. Press **ENTER**

A textbox appears on the screen. (image 13-2)



Image 13-1

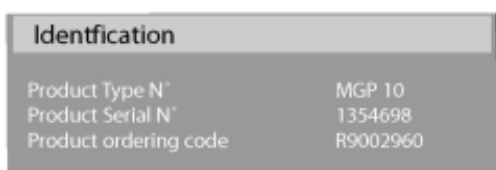

Image 13-2

13.2 Configuration

How to display the configuration screen ?

1. Press **MENU** to activate the Toolbar
2. Press → to select *Information*
3. Press ↓ to Pull down the menu
4. Use ↑ or ↓ to select *Configuration* (image 13-3)
5. Press **ENTER**

A textbox appears on the screen. (image 13-4)

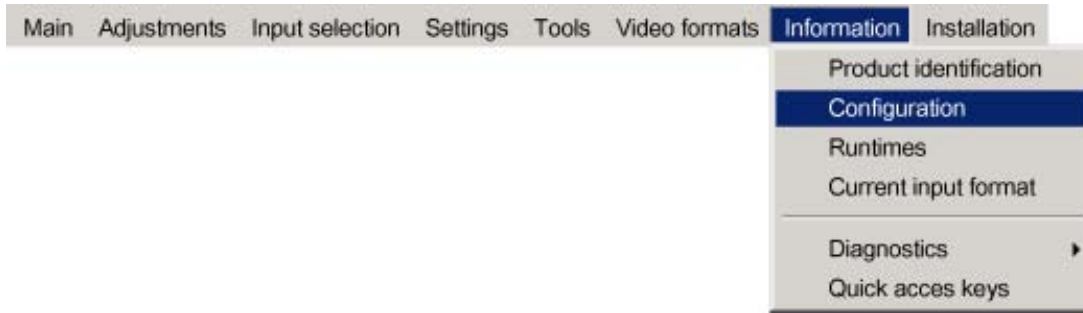

Image 13-3

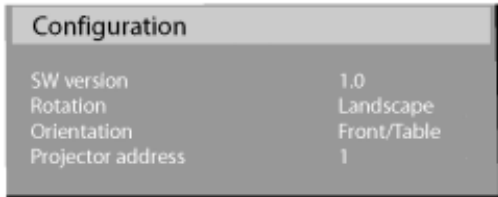

Image 13-4

13.3 Runtimes

How to display the runtimes ?

1. Press **MENU** to activate the Toolbar
2. Press → to select *Information*
3. Press ↓ to Pull down the menu
4. Use ↑ or ↓ to select *Runtimes* (image 13-5)
5. Press **ENTER**

A textbox appears on the screen.

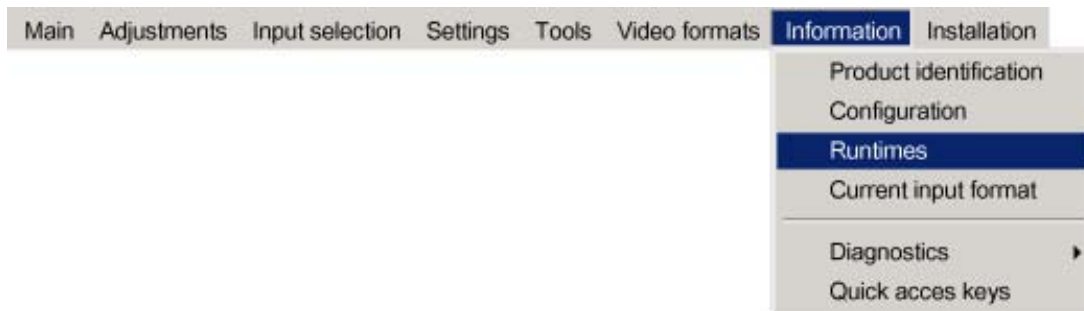

Image 13-5

13.4 Current Input format

How to display the current input format ?

1. Press **MENU** to activate the Toolbar
2. Press → to select *Information*
3. Press ↓ to Pull down the menu
4. Use ↑ or ↓ to select *Current input format* (image 13-6)
5. Press **ENTER**

A textbox appears on the screen. (image 13-7)

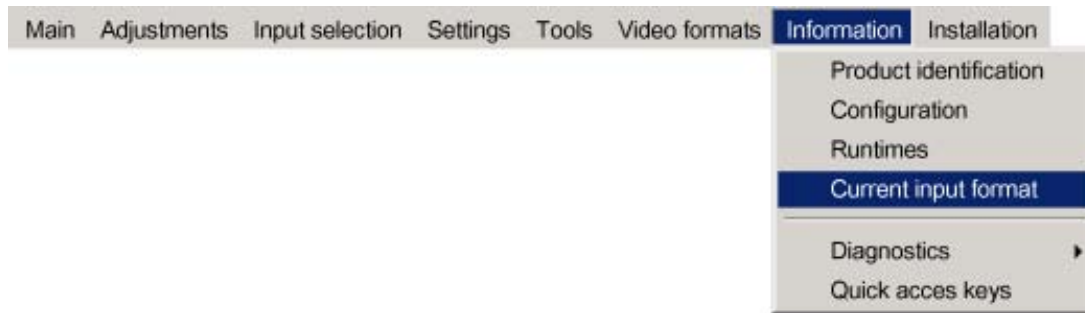

Image 13-6

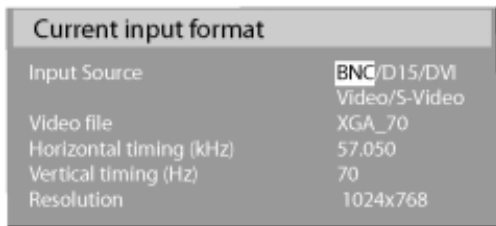

Image 13-7

13.5 Diagnostics

How to display the I2C diagnostics ?

1. Press **MENU** to activate the Toolbar
2. Press **→** to select *Information*
3. Press **↓** to Pull down the menu
4. Use **↑** or **↓** to select *Diagnostics*
5. Press **→** to select *I2C* (image 13-8)
6. Press **ENTER**

A textbox appears on the screen. (image 13-9)

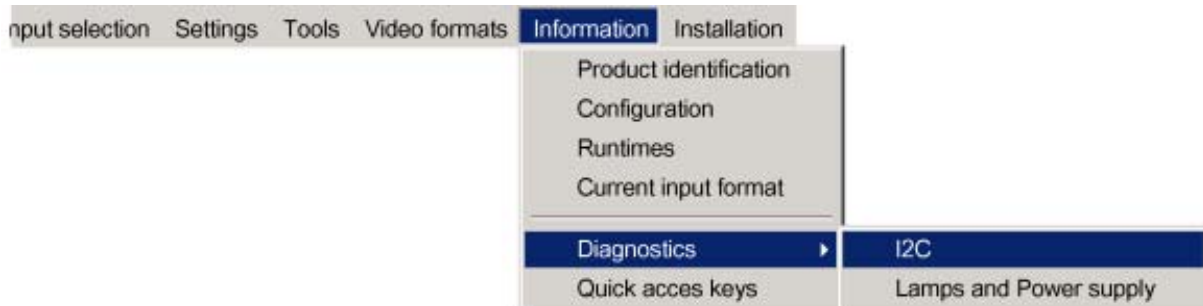

Image 13-8

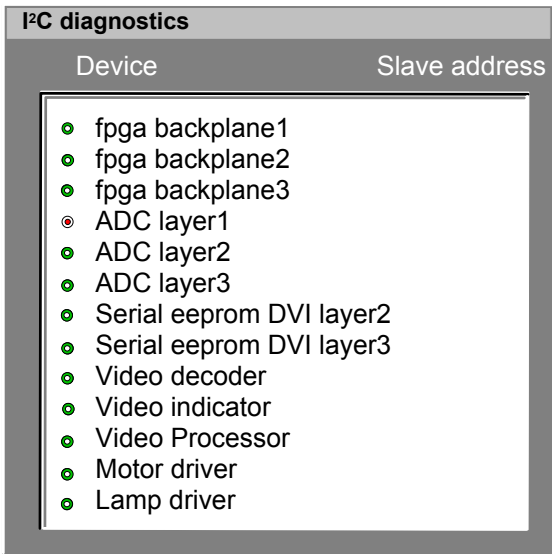

Image 13-9

How to display the Lamps and Power supply diagnostics ?

1. Press **MENU** to activate the Toolbar
2. Press → to select *Information*
3. Press ↓ to Pull down the menu
4. Use ↑ or ↓ to select *Diagnostics*
5. Press → to select *Lamps and power supply* (image 13-10)
6. Press **ENTER**

A textbox appears on the screen.

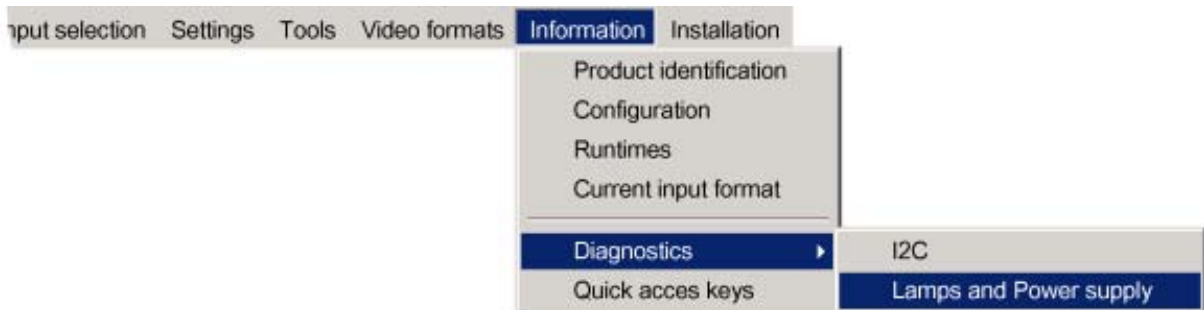

Image 13-10

13.6 Quick access keys

What can be done ?

The 3 function keys on top of the RCU can be associated with a particular item in one of the menus.

Each function which is not password protected or does not have a key on the RCU can associated to a function key.

How to get an overview of the quick access keys ?

1. Press **MENU** to activate the Toolbar
2. Press → to select the *Information*
3. Press ↓ to Pull down the *Information* menu
4. Use ↑ or ↓ to select *Quick access keys* (image 13-11)
5. Press **ENTER**

A textbox appears on the screen.

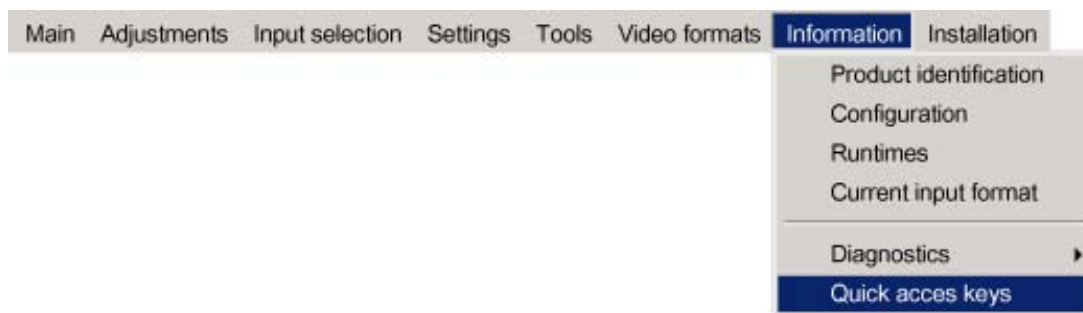

Image 13-11

How to program the quick access keys ?

1. Scroll through the menus to the desired menu item
2. Push the desired function key for 3 seconds

The menu item is stored in the quick access key



Factory pre-programmed functions

- F1 : color depth
 - F2 : noise reduction
 - F3 : orientation
-

14. INSTALLATION

Overview

- Lens adjustments
- Projector address
- Orientation
- Portrait / Landscape
- Language
- RS232 baudrate
- Security
- Change password
- Auto Menu Exit
- Automatic startup
- Textbox
- Menu bar position
- Status bar position
- Sliderbox position

14.1 Lens adjustments

What can be done ?

Motorized lenses can be adjusted in the installation menu or via the dedicated keys on the remote.

The following parameters can be adjusted:

- Zoom
- Focus
- Shift (also for non motorized lenses)
- Testpattern

How to Zoom/focus or shift the lens ?

1. Press **MENU** to activate the Toolbar
2. Press → to select the *Installation*
3. Press ↓ to Pull down the *Installation* menu
4. Use ↑ or ↓ to select *Lens adjustment*
5. Press → to open the menu
6. Use ↑ or ↓ to select *Zoom/Focus or Shift* (image 14-1)
7. Press **ENTER**

A textbox appears on the screen, follow the instructions. (image 14-2, image 14-3)

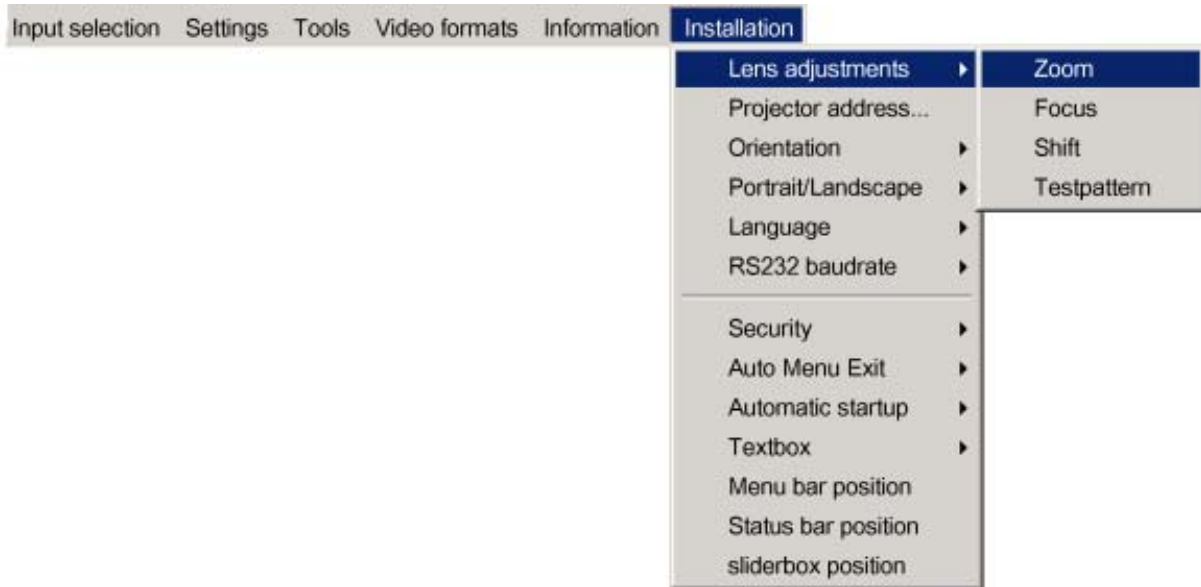

Image 14-1

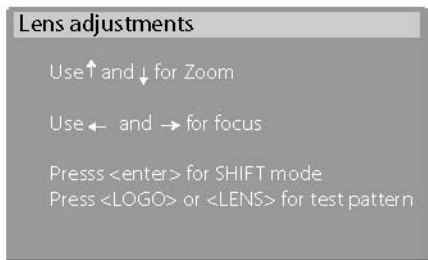

Image 14-2

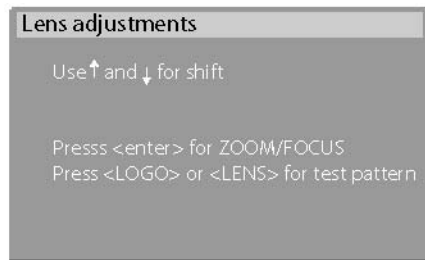

Image 14-3

14.2 Projector address

What can be done ?

In some cases the projector address must be changed, for example if an unique RCU is used to control 2 or more projectors. The projector address setting on the projector must match the setting on the RCU.

What can be changed ?

Within the 'Change Projector Address' menu, the following items can be changed

- Projector address: address defined by the user, may be from 0 to 255
- Common address : address may be 0 or 1
- RS232 address

How to change the projector's RC5 address ?

1. Press **MENU** to activate the Toolbar
2. Press → to select the *Installation*
3. Press ↓ to Pull down the *Installation* menu
4. Use ↑ or ↓ to select *Projector address* (image 14-4)
5. Press **ENTER**
A dialogbox appears on the screen. (image 14-5)

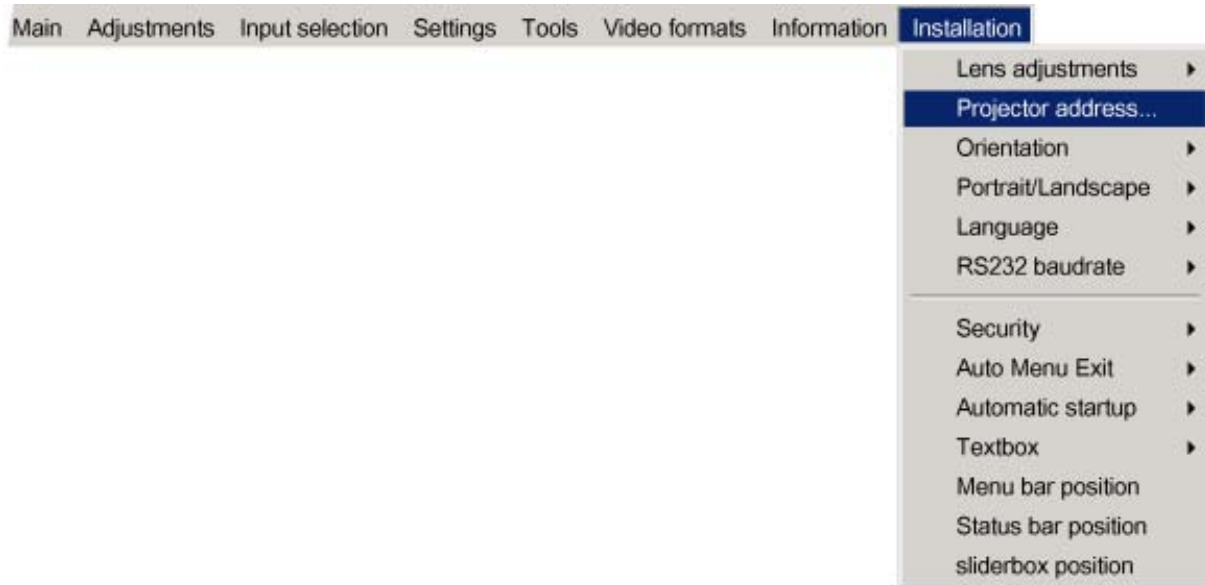

Image 14-4



Image 14-5

14.3 Orientation

Projector orientations

Depending on how the projector is oriented, the projector's internal settings have to be adapted.

How to change the orientation ?

1. Press **MENU** to activate the Toolbar
2. Press → to select the *Installation* item
3. Press ↓ to Pull down the *Installation* menu
4. Use ↑ or ↓ to select *Orientation*
5. Press → to pull down the menu
6. Use ↓ or ↑ to select the desired orientation (image 14-6)
7. Press **ENTER**

The projection is adapted and a bullet shows the active configuration.

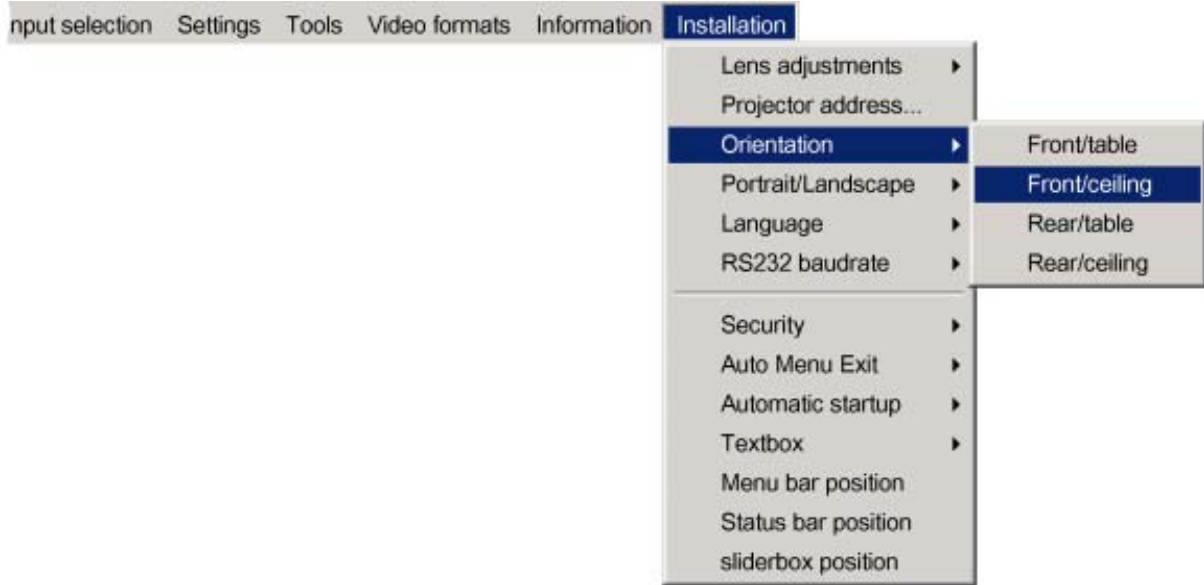

Image 14-6

14.4 Portrait / Landscape

View Mode

The view mode of the MGP 10 can be adapted to be *Portrait* or *Landscape*.

Both view mode are made possible thanks to the corresponding ceiling mount.



Portrait/Landscape setting is done once upon installation, see "Projector configurations", page 12

How to change the view mode ?

1. Press **MENU** to activate the Toolbar
2. Press → to select the *Installation* item
3. Press ↓ to Pull down the *Installation* menu
4. Use ↑ or ↓ to select *Portrait / Landscape*
5. Press → to pull down the menu
6. Use ↓ or ↑ to select the desired mode (image 14-7)
7. Press **ENTER**

The projection is adapted and a bullet shows the active configuration.

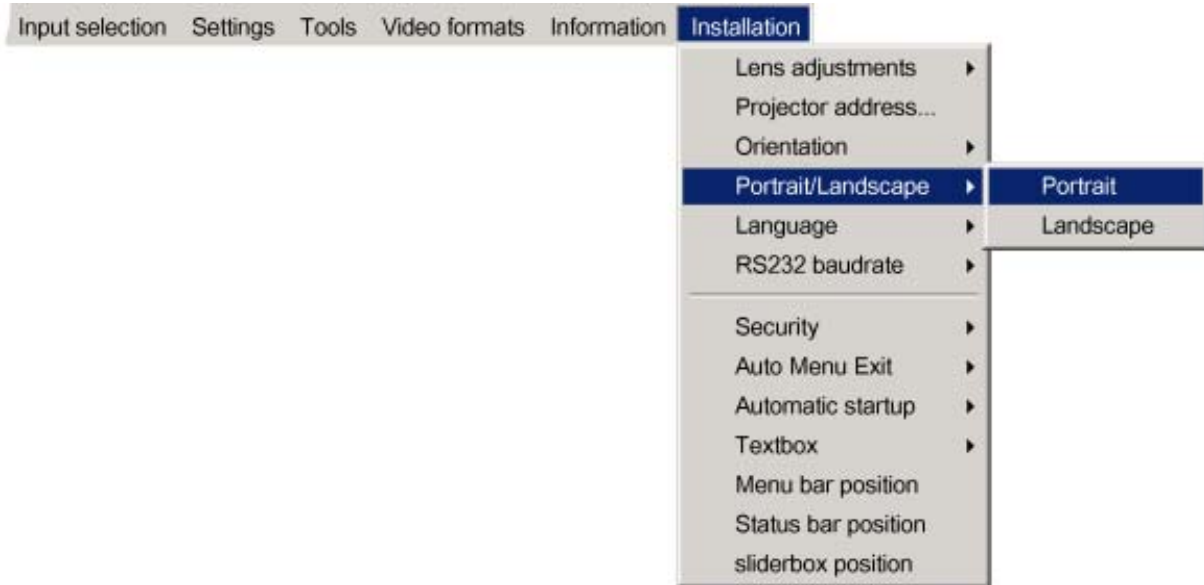

Image 14-7

14.5 Language

List of languages

The list of selectable languages is depending on the software version of the projector.

How to change the Language?

1. Press **MENU** to activate the Toolbar
2. Press → to select the *Installation* item
3. Press ↓ to Pull down the *Installation* menu
4. Use ↑ or ↓ to select *Language*
5. Press → to pull down the menu
6. Use ↓ or ↑ to select the desired language (image 14-8)
7. Press **ENTER**

The language is adapted and a bullet shows the active configuration.

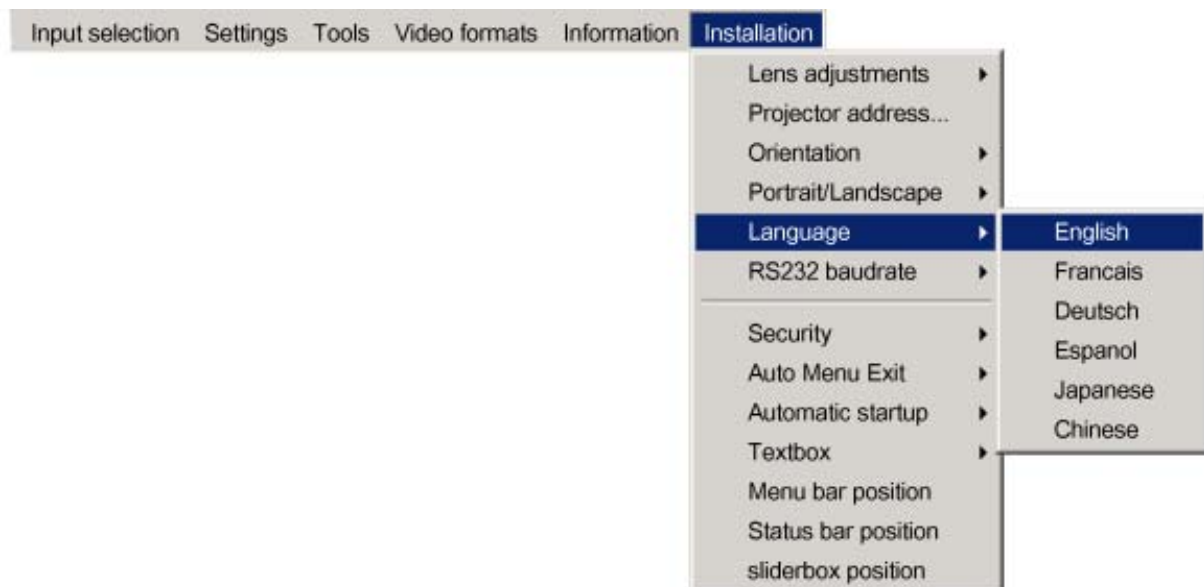

Image 14-8

14.6 RS232 baudrate

How to change the baudrate?

1. Press **MENU** to activate the Toolbar
2. Press → to select the *Installation* item
3. Press ↓ to Pull down the *Installation* menu
4. Use ↑ or ↓ to select *RS232 baudrate* (image 14-9)
5. Press → to pull down the menu
6. Use ↓ or ↑ to select the desired baudrate
7. Press **ENTER**

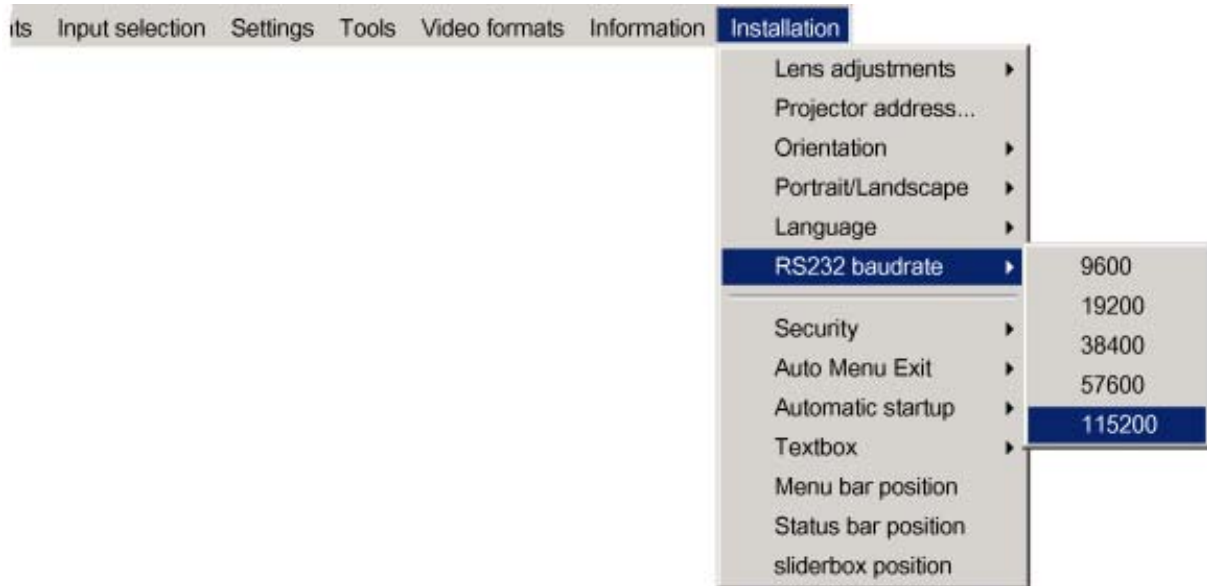

Image 14-9

14.7 Security

What can be done ?

A security function is implemented in the projector and allows a protection against theft.

A PIN code allows the user to lock the projector in case of wrong code entry.

The PIN code must be entered at each start up (Power ON), entering three times a wrong number triggers a wait cycle of 15 minutes, the second 3 wrong codes a wait cycle of 30 minutes, 1 hour, ...

The security mode can be enabled or disabled.

How to activate the security mode ?

1. Press **MENU** to activate the Toolbar
2. Press → to select the *Installation* item
3. Press ↓ to Pull down the menu
4. Use ↑ or ↓ to select *Security* (image 14-10)
5. Press → to open the menu
6. Use ↑ or ↓ to select *ON*
7. Press **ENTER**

A dialogbox is displayed (image 14-11)

8. Use the arrow keys to select YES and press **ENTER** to confirm

A dialogbox is displayed

Enter your name, company name,... (this information is displayed in the identification menu) (image 14-12)

9. Press ACCEPT

A dialogbox is displayed.

Enter the PIN code, and confirm it. (image 14-13)

An informative textbox is then displayed. Press **ENTER** or **BACK** to escape. (image 14-14)

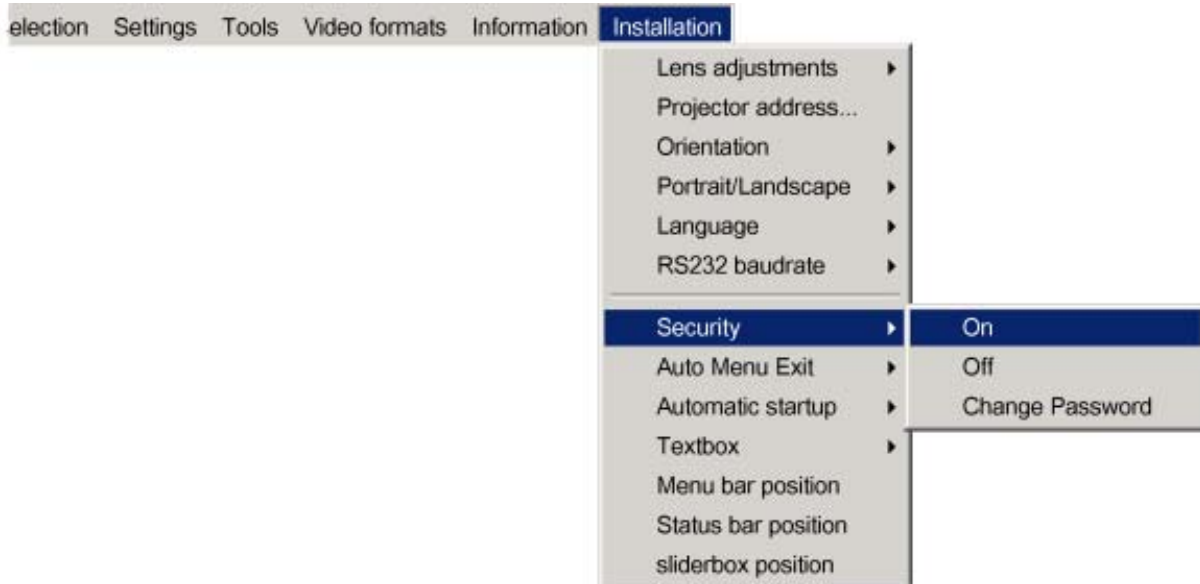

Image 14-10



Image 14-11



Image 14-12

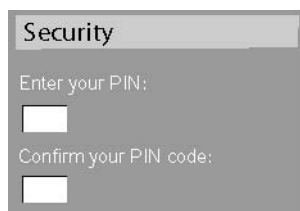

Image 14-13

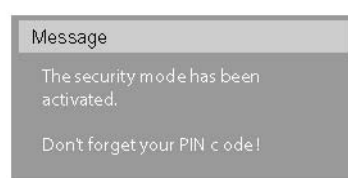

Image 14-14

How to disable the security mode ?

1. Press **MENU** to activate the Toolbar
2. Press → to select the *installation* item
3. Press ↓ to Pull down the menu

14. Installation

4. Use ↑ or ↓ to select *Security*
5. Press → to open the menu
6. Use ↑ or ↓ to select *OFF* (image 14-15)
7. Press **ENTER**
A dialogbox is displayed
8. Enter your PIN code
The security mode is now disabled

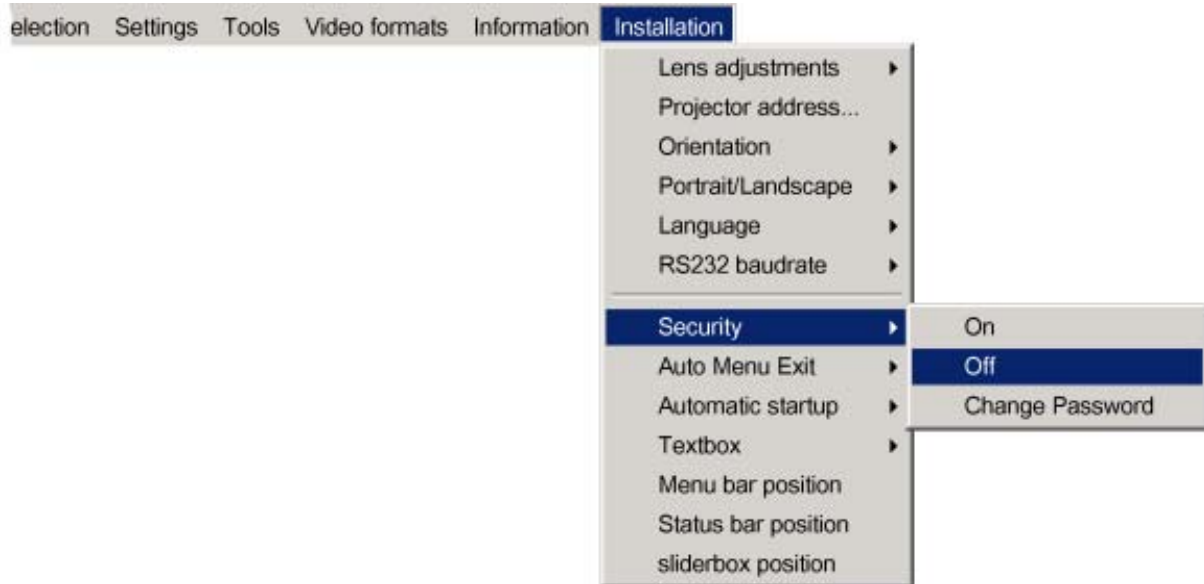

Image 14-15

14.8 Change password

How to change the password ?

1. Press **MENU** to activate the Toolbar
2. Press → to select the *Installation* item
3. Press ↓ to Pull down the *Installation* menu
4. Use ↑ or ↓ to select *Change password* (image 14-16)
5. Press **ENTER**
A dialogbox is displayed. (image 14-17)
6. Use ← or →, the numeric keys on the remote, or the keypad to enter and confirm the new password.
Each character is displayed as an asterisk.

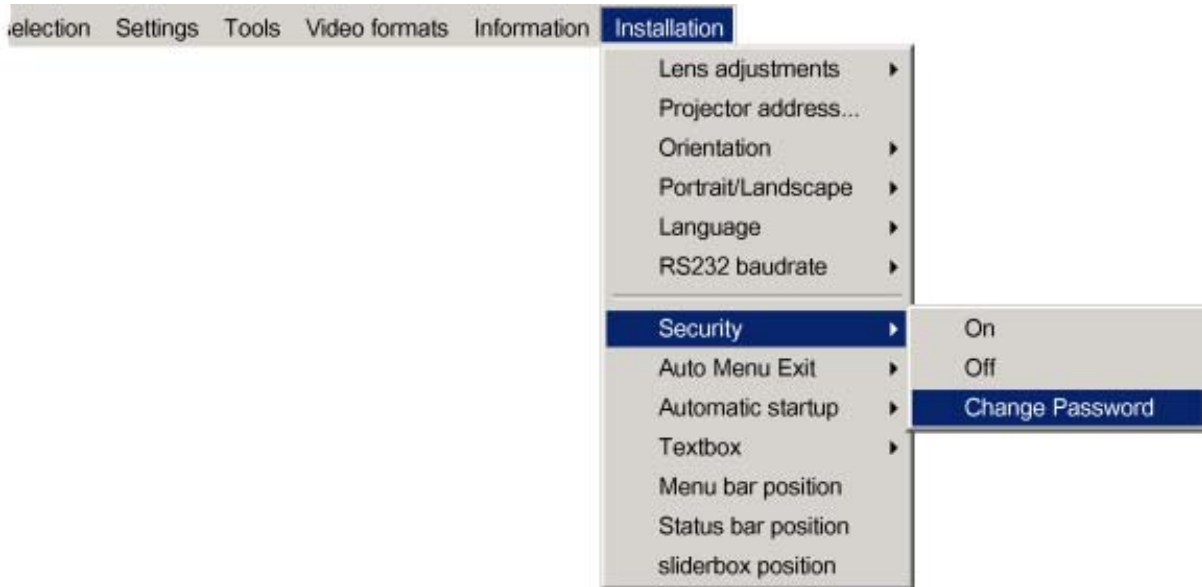

Image 14-16



Image 14-17



The new password is accepted if the new password and the confirmed password coincide.



If the password is forgotten contact a Barco authorized technician.

14.9 Auto Menu Exit

Purpose

The Auto menu exit allows to quit automatically the menu after 1 minute of inactivity.

How to enable the Auto Menu Exit ?

1. Press **MENU** to activate the Toolbar
2. Press → to select the *Installation* item
3. Press ↓ to Pull down the *Installation* menu
4. Use ↑ or ↓ to select *Auto Menu Exit* (image 14-18)
5. Press **ENTER**

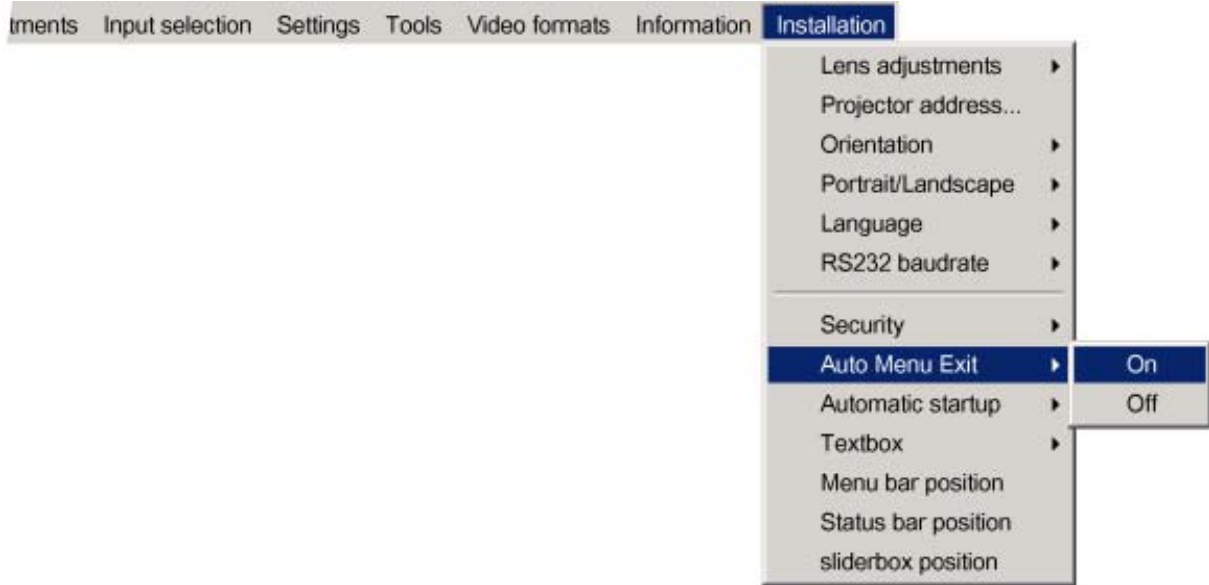

Image 14-18

14.10 Automatic startup

What can be done ?

The automatic startup allows immediate restart of the projector after a power failure (breakdown), i.e. without passing through the standby state.

The projector restarts at power resume and recovers the previous settings (previous source,...).

This function can be disabled if undesired or inadequate for safety reasons, etc.



CAUTION: If the Automatic startup function is enabled one must be aware of the fact that it involves safety precautions

Make sure that the projector (or the operators!) will not be affected by altered environmental conditions when restarting at power resume.

How to enable/disable the Automatic startup?

1. Press **MENU** to activate the Toolbar
2. Press → to select the *Installation* item
3. Press ↓ to Pull down the *Installation* menu
4. Use ↑ or ↓ to select *Automatic startup*
5. Press → to pull down the menu
6. Use ↓ or ↑ to enable/disable the automatic startup (image 14-19)
7. Press **ENTER**

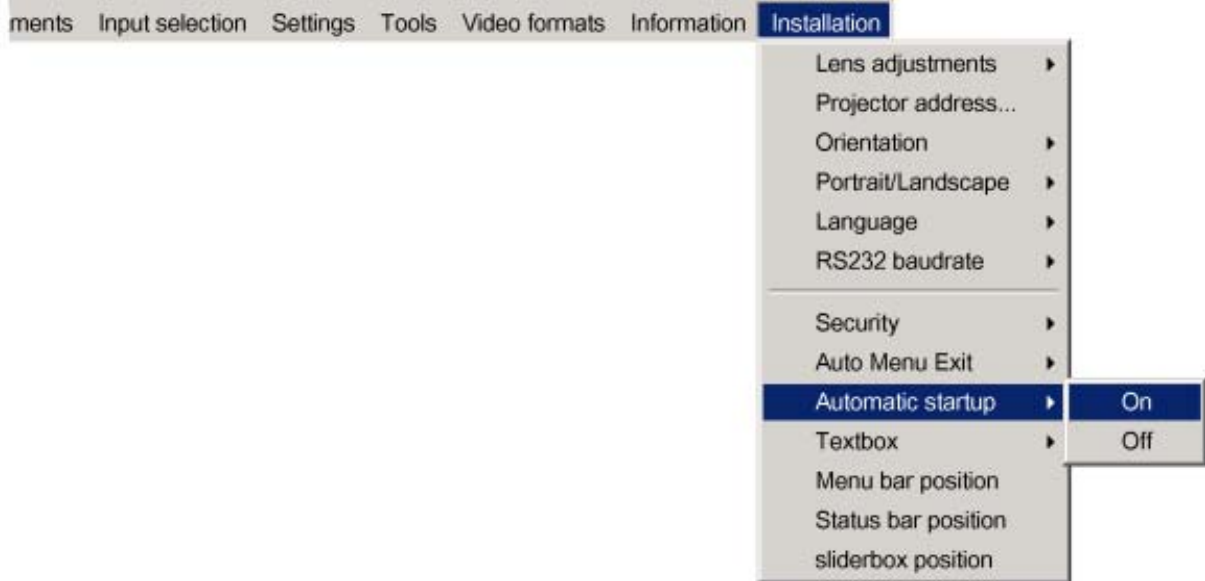

Image 14-19

14.11 Textbox

What can be done ?

The textbox function allows to display or not the different sliderboxes used for instance for picture settings (contrast,...), it also affects the source information windows (displayed in the right lower corner of the screen).

How to enable/disable the Textbox ?

1. Press **MENU** to activate the Toolbar
2. Press → to select the *Installation* item
3. Press ↓ to Pull down the *Installation* menu
4. Use ↑ or ↓ to select *Textbox*
5. Press → to pull down the menu
6. Use ↓ or ↑ to enable/disable the textbox (image 14-20)
7. Press **ENTER**

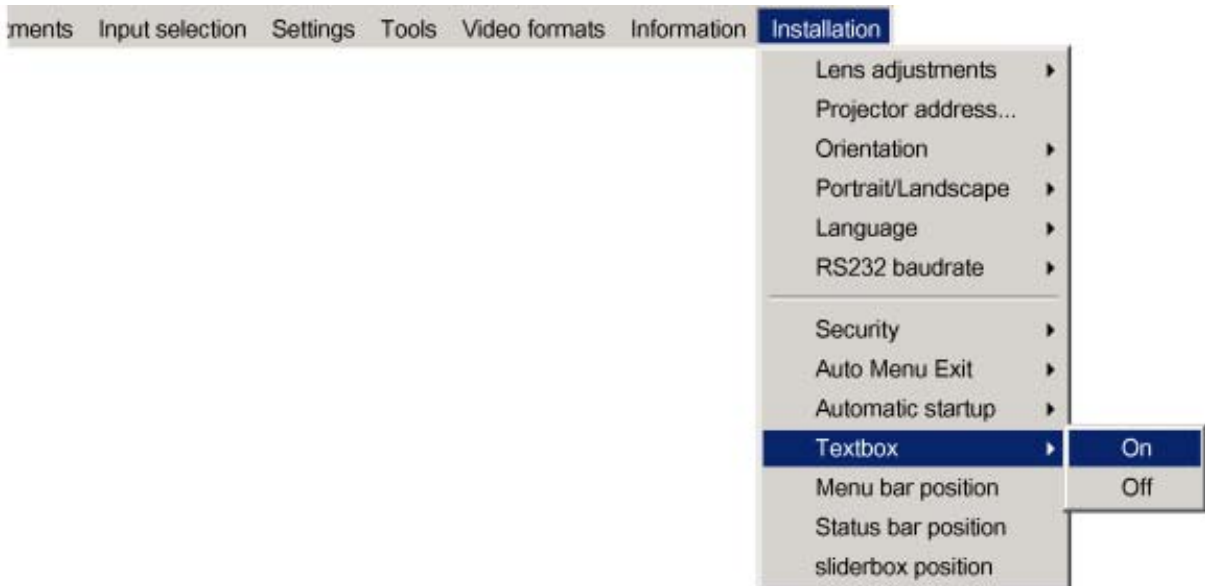

Image 14-20

14.12 Menu bar position

What can be done ?

The menu toolbar can be centered vertically , the range being from top of the screen to the middle of the screen. This can be useful in applications where the top image content is not displayed.

How to center the menu ?

1. Press **MENU** to activate the Toolbar
2. Press → to select the *Installation* item
3. Press ↓ to Pull down the *Installation* menu
4. Use ↑ or ↓ to select *Menu bar position menu* (image 14-21)
5. Press **ENTER**
6. Use ↑ or ↓ to position the menu toolbar



Image 14-21

14.13 Status bar position

What can be done ?

The status bar (wizard menu) can be centered vertically , the range being from bottom of the screen to the middle of the screen. This can be useful in applications where the bottom image content is not displayed.

How to center the menu ?

1. Press **MENU** to activate the Toolbar
2. Press → to select the *Installation* item
3. Press ↓ to Pull down the *Installation* menu
4. Use ↑ or ↓ to select *Status bar position* (image 14-22)
5. Press **ENTER**
6. Use ↑ or ↓ to position the status bar



Image 14-22

14.14 Sliderbox position

What can be done ?

The sliderbox can be displayed anywhere on the screen, the position can be set in this menu.

How to reposition the sliderbox?

1. Press **MENU** to activate the Toolbar
2. Press → to select the *Installation* item
3. Press ↓ to Pull down the *Installation* menu
4. Use ↑ or ↓ to select *Sliderbox position* (image 14-23)
5. Press **ENTER**

A sliderbox is displayed. Use the 4 arrow keys to drag the box to the desired position. (image 14-24)



Image 14-23

14. Installation

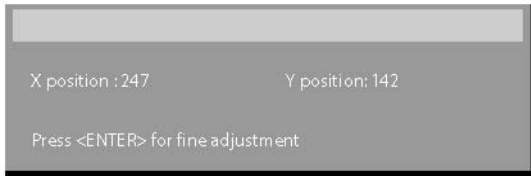

Image 14-24



There is a coarse and a fine adjustment of the position, use ENTER (when sliderbox is displayed) to switch between the two.

15. CLEANING THE DUSTFILTERS

Overview

- Dustfilters
- Cleaning

15.1 Dustfilters

Location of the filters

There are 4 filters located at different positions

1. Filter1: Lamp 1
2. Filter2 : Lamp 2
3. Filter 3 : X-Cube filter
4. Filter 4 : Input filter

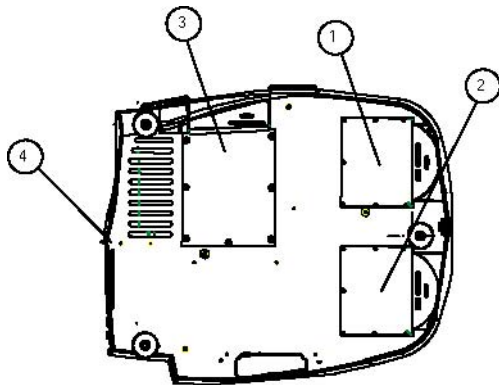

Image 15-1
location of the filters

- 1 lamp filter 1
- 2 lamp filter 2
- 3 x-cube filter
- 4 input filter

15.2 Cleaning

How to clean the dustfilters ?

1. Place the projector so as to access easily the filter to be cleaned
2. Push the handle downwards to unlock the filter. (image 15-2)
3. Slide out the filter (image 15-3, image 15-4, image 15-5)
See image 15-6.
4. Clean the dust filter with a dry cloth.
5. Re-insert the dust filter by sliding it back in the filter housing.

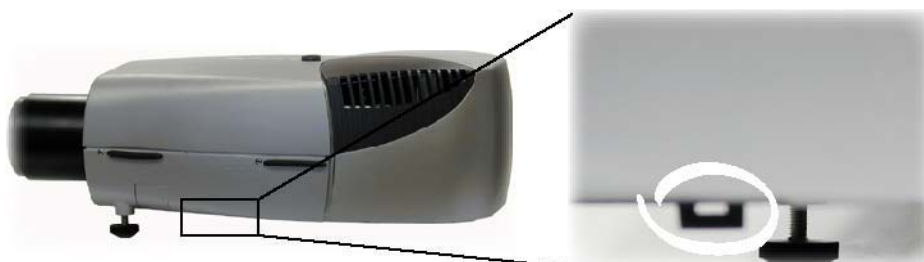

Image 15-2
Location of the x-cube filter and its handle

15. Cleaning the dustfilters



Image 15-3
Lamp filter removal



Image 15-4
lamp & X-Cube filters removed

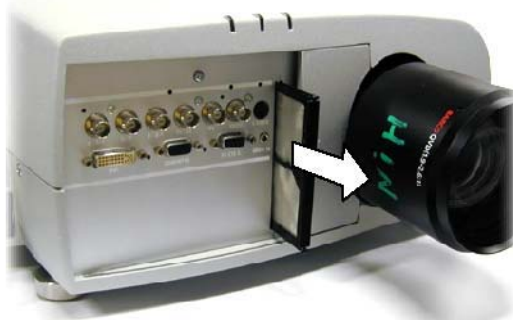

Image 15-5
Input filter removal



Image 15-6
Input filter removed



If the airflow is falling under a predetermined threshold value a warning will be displayed on the screen.

Message

An insufficient airflow is detected
Please check your dustfilter
at the airflow entrance

Image 15-7

At that time it is strongly recommended to replace or clean the dustfilter under the X-cube. Failing to do so, will strongly reduce the lifetime of the LCD's and the analyzers.

The manufacturer reserves itself the right to refuse warranty repair if the projector was working with dirty dustfilters.

16. STANDARD IMAGE FILES

16.1 Table overview

Table overview

The following standard image files are pre-programmed in the projector.

Name ³	Resolution ⁴	Fvert Hz ⁵	FHor kHz ⁶	Fpix MHz ⁷	Ptot ⁸	Pact ⁹	Ltot ¹⁰	Lact ¹¹
1600_48V	1600x600i	48,040	62,500	135,000	2160	1600	651	600
CGA	640x200i	59,924	15.700	14.318	912	640	262	200
COMPUSC4	1024x480i	29,945	30,694	39,779	1296	1024	512	480
DOS1_70	720x400	70	31,500	28,350	900	720	449	400
DOS3_56	640x400	56	24,800	21,030	848	640	440	400
DOS4_85	640x400	85	37,860	31,500	832	640	445	400
EGA	640x350	59,702	21,851	16,257	744	640	366	350
ESVGA_75	832x624	73	47,900	53,648	1120	832	660	624
EXGA_60	1152x864	60	54,900	79,934	1456	1152	916	864
EXGA_80	1152x864	80,000	76,499	110,159	1140	1152	958	864
EXGA_85	1152x864	85 ,000	77,202	121,671	1576	1152	907	864
EXGA1_70	1152x864	70	63,800	94,424	1480	1152	912	864
EXGA1_75	1152x864	75	67,499	107,999	1600	1152	900	864
EXGA2_70	1152x864	70	66,098	99,941	1512	1152	945	864
EXGA2_75	1152x864	75	75,199	110,092	1464	1152	1002	864
FMR	640x400i	42,323	36,440	28,570	784	640	431	400
GE_50	640x400	50	31,200	44,928	1440	1163	625	522
GE_60	1085x480	60	30,700	41,261	1344	1085	512	480
hd_1080i	1920x540	60	33,750	74,249	2200	1920	563	540
hd_24p	1920x1080	24,000	27,000	74,000	2750	1920	1125	1080
hd_24sf	1950x540	48,000	27,000	74,000	2750	1950	562	540
hd_25i	1920x540	50,000	28,125	74,000	2640	1920	562	540
hd_25p	1920x1080	25,000	28,125	74,000	2640	1920	1125	1080

3. Name: name of file, contains the settings.

4. Resolution: image resolution, when followed by ..i means interlaced.

5. Fvert Hz: vertical frame frequency of the source

6. FHor kHz: horizontal frequency of the source

7. Fpix MHz: pixel frequency

8. Ptot : total pixels on one horizontal line.

9. Pact: active pixels on one horizontal line.

10. Ltot: total lines in one field

11. Lact: active lines in one field.

16. Standard Image Files

Name ³	Resolution ⁴	Fvert Hz ⁵	FHor kHz ⁶	Fpix MHz ⁷	Ptot ⁸	Pact ⁹	Ltot ¹⁰	Lact ¹¹
hd_30p	1920x1080	30,000	33,750	74,000	2200	1920	1125	1080
hd_60p	1280x720	60,000	45,000	74,000	1650	1280	750	720
INTER_GR	1184x886	67,170	61,796	92,941	1504	1184	920	886
IQPC_SXGA_2	1366x1024	59	62,933	106,230	1688	1366	1067	1024
IQPC_SXGA_D	1280x1024	60	63,857	107,791	1688	1280	1063	1024
IQPC_XGA_1	1024x768	61	49,005	65,863	1344	1024	807	768
IQPC_XGA_2	1024x768	60	48,485	65,164	1344	1024	807	768
IQPC_XGA_D	1024x768	61	49,005	65,863	1344	1024	806	768
MAC_3	512x384	60,147	24,480	15,667	640	512	407	384
MAC_4	560_384	60,147	24,480	17,234	704	560	407	384
MAC_5	512x342	60,158	22,259	16,670	704	512	370	342
MAC_6	832x624	74,546	49,722	57,280	1152	832	667	624
MAC_7	1024x768	74,907	60,150	80,000	1330	1024	803	768
MAC_POR	640x870	74,996	68,846	57,280	932	640	918	870
METH_BOOT1	720x400	70	31,500	28,350	900	720	448	400
METH_BOOT2	640x480	59	31,000	24,800	800	640	524	480
MXGA_100	1152x864	100	92,997	145,820	1568	1152	930	864
NTSC	675x240	60	15,748	13,512	858	675	263	240
PAL	675x286	50	15,625	13,500	864	675	313	286
PAL_LIMO_x2	834x574	50	31,250	32,000	1024	834	626	574
PAL_LIMO_x3	834x850	50	46,296	47,407	1024	834	926	850
PAL_LIMO_x4	834x1146	50	62,500	64,000	1024	834	1250	1146
PAM500	640x400	60,000	26,400	22,810	864	640	440	400
PAM800	1120x375i	44,936	36,443	50,000	1372	1120	406	375
PC98_2	1120x375i	39,994	32,835	47,840	1457	1120	411	375
PC98_3	1120x750	60,000	50,000	78,569	1571	1120	833	750
S1152_66	1152x900	66,004	61,846	94,500	1528	1152	937	900
S1152_76	1152x900	76,637	71,809	108,000	1504	1152	937	900
S1600_67	1600x1280	67	89,286	200,000	2240	1600	1334	1280
SDI_625	675x278i	25,000	15,625	13,500	864	720	313	278
SDI_525	675x240i	29,970	15,734	13,500	858	720	263	240
STOR_100	764x287	100	31,300	30,361	970	764	313	287

Name ³	Resolution ⁴	Fvert Hz ⁵	FHor kHz ⁶	Fpix MHz ⁷	Ptot ⁸	Pact ⁹	Ltot ¹⁰	Lact ¹¹
STOR_120	810x247	119	31,300	30,361	970	810	263	247
STOR_50	1024x512	50	31,300	40,064	1280	1024	625	512
STOR_60	1024x512	60	31,300	40,064	1280	1024	525	512
SUNNEWS67	1280x1024	67,189	71,691	117,000	1632	1280	1067	1024
SUNNEWS76	1280x1024	76,107	81,130	135,000	1664	1280	1066	1024
SUNXGA60	1024x768	59,984	48,287	64,125	1328	1024	805	768
SUNXGA70	1024x768	70,041	56,596	74,250	1312	1024	808	768
SUNXGA77	1024x768	77,069	62,040	84,375	1360	1024	805	768
SUP_MAC	1024x768	60,000	48,780	63,999	1312	1024	813	768
SVGA_56V	800x600	56,250	35,156	36,000	1024	800	625	600
SVGA_60V	800x600	60,317	37,879	40,000	1056	800	628	600
SVGA_72_1	800x600	72,084	48,080	50,003	1040	800	666	600
SVGA_72_2	800x600	72,084	48,080	50,003	1040	800	667	600
SVGA_75	800x600	75,000	46,875	75,000	1056	800	625	600
SVGA_85	800x600	85,000	53,635	56,250	1048	800	631	600
SXGA_72_1	1280x1024	72	76,699	128,854	1680	1280	1061	1024
SXGA_72_2	1280x1024	72	76,970	130,080	1690	1280	1069	1024
SXGA_75	1280x1024	75	79,974	134,997	1688	1280	1066	1024
SXGA_76	1280x1024	76	81,103	134,955	1664	1280	1066	1024
SXGA_85	1280x1024	85	91,149	157,506	1728	1280	1072	1024
SXGA_L	1280x1024	60	62,500	84,000	1344	1280	1041	1024
SXGA2_60	1280x960	60	59,999	107,998	1800	1280	1000	960
SXGA2_85	1280x960	85	85,940	148,505	1728	1280	1011	960
SXGA50	1280x1024	50	52,351	88,368	1688	1280	1047	1024
SXGA60v	1280x1024	60	63,658	110,001	1728	1280	1056	1024
SXGAP_70	1024x1280	70	92,902	133,779	1440	1024	1326	1280
SXGAP1_60	1024x1280	60	77,700	83,916	1080	1024	1297	1280
SXGAP2_60	1024x1280	60	79,498	110,661	1392	1024	1325	1280
UXGA_60	1600x1200	60	75,002	162,004	2160	1600	1250	1200
UXGA_65	1600x1200	65	81,248	175,496	2160	1600	1250	1200

16. Standard Image Files

Name ³	Resolution ⁴	Fvert Hz ⁵	FHor kHz ⁶	Fpix MHz ⁷	Ptot ⁸	Pact ⁹	Ltot ¹⁰	Lact ¹¹
UXGA_70	1600x1200	70	87,497	188,993	2160	1600	1250	1200
UXGA_75	1600x1200	75	93,747	202,494	2160	1600	1250	1200
UXGA_85	1600x1200	85	106,247	229,494	2160	1600	1250	1200
UXGA_L	1600x1200	60	72,801	119,977	1648	1600	1216	1200
UXGAP1_60	1200x1600	59	95,804	119,946	1252	1200	1620	1600
UXGAP2_60	1200x1600	60	99,404	163,817	1648	1200	1656	1600
VGA_60	640x480	60	31,326	25,061	800	640	525	480
VGA_66	640x480	67	35,100	30,326	864	640	525	480
VGA_72	640x480	73	37,860	31,500	832	640	520	480
VGA_75	640x480	75,000	37,500	31,500	840	640	500	480
VGA1_85	640x480	85,000	43,369	36,000	832	640	509	480
VGA2_85	720x400	85,000	37,900	35,475	936	720	446	400
VGA75ISO	640x480	75,000	39,375	31,500	800	640	525	480
VIDEO525	1302x239i	29,970	15,734	32,207	1302	1024	263	239
VIDEO625	1024x278i	25,000	15,625	31,984	1310	1024	313	278
XGA_43	1024x384	87	35,500	44,872	1264	1024	409	384
XGA_60	1024x768	60,000	48,360	64,996	1344	1024	806	768
XGA_70_1	1024x768	70,000	56,475	74,999	1328	1024	806	768
XGA_70_2	1024x768	70,000	57,052	78,047	1368	1024	815	768
XGA_72	1024x768	71,955	58,140	80,000	1376	1024	808	768
XGA_75_1	1024x768	75	60,024	78,752	1312	1024	800	768
XGA_75_2	1024x768	76	61,080	86,000	1408	1024	806	768
XGA_85	1024x768	85,000	68,680	94,500	1376	1024	808	768
XGA_EOS	1024x768	63,000	50,000	67,200	1344	1024	796	768
XGA75_GS	1024x768	74,534	59,701	79,284	1328	1024	801	768

Table 16-1